

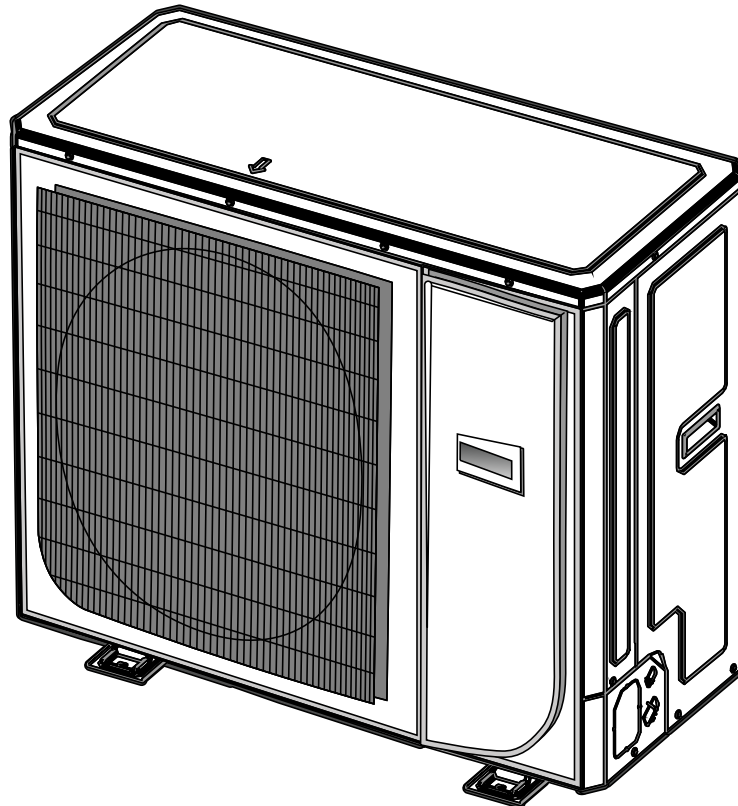

Service Manual



Connect Series Split Heat Pumps



Foreword

Thank you for choosing GE Appliances Connect Series heat pumps.. Please read this manual carefully in order to properly install the equipment and maximize customer satisfaction.

This manual specifies safe operation requirements from perspectives of product introduction, control, troubleshooting and maintenance, as well as basic principles and implementation methods. Professional operators must abide by relevant national (local) safety requirements and technical specifications set forth in this manual during operations; otherwise, the air conditioning system may fail or be damaged, and personnel safety may be compromised.

	Please read this manual before installing this heat pump.
	Before repairing the air conditioner, please first read the technical service manual.
	Please read this instruction manual before operating this heat pump.

Contents

Safety Notifications	1
Introduction	3
Lists of Units.....	3
Specifications	4
Controls	6
Operation Modes.....	6
Control Modes	8
Functions.....	9
Troubleshooting	14
Wiring Diagrams.....	14
PCB Layout.....	18
Indoor Unit LED Indicators.....	27
Outdoor Unit Error Codes.....	27
Troubleshooting.....	28
Failures Not Caused by Errors	42
Maintenance	43
System Diagram.....	43
System Evacuation	43
Refrigerant Charging	44
Maintenance of Major Components.....	45
Removal of Major Components	52
Exploded View and Parts Lists	86
Appendices	93
Temperature Sensor Temperature/Resistance/Voltage Lists	93
15 K Ω Temperature Sensors (including ODU temperature sensors).....	93
20 K Ω Pipeline Temperature Sensors (including temperature sensors for defroster, IDU and ODU pipes)	95
50 K Ω Discharge Temperature Sensors (including discharge air temperature sensor).....	97
Refrigerant R-410A Temperature/Pressure List	99
Operation Tools.....	101

Safety Notifications

Maintenance Safety

PROHIBITED:

- Do not pierce or burn.
- Please note that refrigerant may be odorless.
- The appliance shall be stored in a room without continuously operating ignition sources (For example: open flames, an operating gas appliance or an operating electric heater).
- Indoor unit adopts special joints that can't be detached. The installation method is the same with the common joints. Because the joint can't be detached and if it is leaking; it must be cut out and replaced with a braze joint.
- Using unsuitable parts or tools may lead to electric shock or fire hazard.
- Please ventilate the room immediately if refrigerant leaks during maintenance. Heavy leakage may lead to breathing difficulty, severe injury or death.
- Disconnect power before disassembling the appliance for maintenance.
- The appliance should be maintained and cared by authorized technical personnel with necessary qualifications.

WARNING:

- If the unit location is more than 6 feet high, please wear a safety helmet, gloves and a safety belt.
- Never mix any other substances except the specified refrigerant into the refrigerant circuit.
- Check the location to see if the weight can be properly supported before installing the unit.
- Please test the system for leaks prior to charging. Leaks discovered after the unit start up require refrigerant pump-down, leak repair and recharging. Do not allow refrigerant to leak into unventilated spaces.
- Prepare suitable tools and protectors.
- Please isolate all power to the system while making repairs and performing maintenance.

NOTICE:

- This unit requires a proper earth ground per local and national electrical codes.
- Never repair the unit with wet hands. Operating the unit with wet hands may lead to electric shock.
- Isolate all power sources before cleaning the unit.
- All field installed wiring must conform to local and national electric codes.
- Brazing, welding and cutting must be done in properly ventilated areas.
- Gas appliances, heaters and other fire sources should be kept away from the installation and maintenance site.
- Maintenance should be done according to manufacturer's instructions.

OBSERVED:

- Check all condensate drain outlets during maintenance and operational checks.
- Unit should be installed level and on a surface that will sufficiently support its weight.
- Disassembly of the unit, handling of the refrigerant, oil and accessories should all be done according to applicable local rules and regulations.

Safety Notifications

Operation Safety

PROHIBITED:

- Never try to modify the unit, otherwise, it may cause electric shock, overheat or fire hazard.
- Replace all wires that have worn or damaged insulation.
- This equipment must have a dedicated electrical circuit and service disconnect switch.

WARNING:

- Maintain a regular schedule for preventative maintenance.



NOTICE:

- Do not remove the fan cover while the unit is running.
- Use soap and water only to clean the unit. Do not use any solvents to clean the control panel.
- Isolate all power to the system before cleaning the unit.





Introduction

Lists of Units

Outdoor Units

Model	Power Supply	Circuit Breaker Capacity	Appearance
	V/Ph/Hz	A	
AUH2436ZGDA	208/230V-1Ph-60Hz	35	
AUH4860ZGDA	208/230V-1Ph-60Hz	45	

Indoor Units

Model	Cooling/Heating Capacity (Btu/h)	Power Supply	Fuse Capacity	Circuit Breaker Capacity	Appearance
		V/Ph/Hz	A	A	
UUY24ZGDAA	24000/24000	208/230V-1Ph-60Hz	3.5	15	
UUY36ZGDAA	36000/36000	208/230V-1Ph-60Hz	3.5	15	
UUY48ZGDAA	48000/48000	208/230V-1Ph-60Hz	3.5	15	
UUY60ZGDAA	54000/54000	208/230V-1Ph-60Hz	3.5	15	
UUY24ZGDAB	24000/24000	208/230V-1Ph-60Hz	3.15	15	
UUY36ZGDAB	36000/36000	208/230V-1Ph-60Hz	3.15	15	
UUY48ZGDAB	48000/48000	208/230V-1Ph-60Hz	3.15	15	
UUY60ZGDAB	54000/54000	208/230V-1Ph-60Hz	3.15	15	

Introduction

UUY(--)ZGDAA Specifications

Outdoor Unit		AUH2436ZGDA		AUH4860ZGDA	
UPC		0-84691-85465-4		0-84691-85469-2	
Capacity Selection		24K	36K	48K	60K
Indoor Unit		UUY24ZGDAA	UUY36ZGDAA	UUY48ZGDAA	UUY60ZGDAA
UPC		0-84691-85716-7	0-84691-85717-4	0-84691-85718-1	0-84691-85719-8
Cooling	Cooling Capacity Btu/hr.	24,000	36,000	48,000	54,000
	SEER	20	18	18	17
	EER	12.5	11	11	10.5
	Cooling Operating Range	5-129°F (-15-54°C)		5-129°F (-15-54°C)	
Heating	Heating Capacity Btu/hr.	24,000	36,000	48,000	54,000
	HSPF	10.5	10	10.5	10
	Heating Operating Range	-22-75°F (-30-24°C)		-22-75°F (-30-24°C)	
	Electric Backup Heat Kits	8kW		15kW	
Indoor Unit	Airflow CFM	940	1000	1470	1600
	Indoor Sound Level dB	49	49	50	51
	Metering Device	TXV		TXV	
	Power Supply	208/230V/1Ph/60Hz		208/230V/1Ph/60Hz	
	Breaker Size A	15		15	
	Maximum Static Pressure W.C.	.05		0.6	
	Dimension: H x W x D in. (mm)	48 1/4 x 21 1/4 x 21 1/4 (1226 x 540 x 540)		57 x 24 3/4 x 21 1/4 (1448 x 630 x 540)	
	Carton Dimension: H x W x D in. (mm)	50 1/2 x 26 x 23 3/4 (1283 x 660 x 603)		59 3/8 x 27 1/4 x 26 (1508 x 693 x 660)	
Weight Net/Gross - lbs. (kg)	156.5/169.8 (71/77)		202.8/218.3 (92/99)		
Control	Control Voltage	24VAC		24VAC	
Piping	Refrigerant Type	R410A		R410A	
	Liquid O.D. in.	3/8		3/8	
	Suction O.D. in.	3/4		3/4	
	Piping Connection	FLARE		FLARE	
	Factory Charge lbs. (kg)	9.26 (4.2)		13.78 (6.25)	
	Maximum Line Length ft. (m)	164 (50)		98 (30)	
	Maximum Height ft. (m)	50 (15)		50 (15)	

Compatible Electric Heat Kits

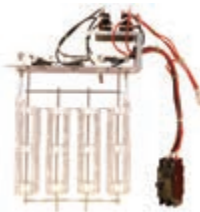

AHU #	UUY24ZGDAA / UUY36ZGDAA	UUY48ZGDAA / UUY60ZGDAA
Kit Model #	UAZEH08A	UAZEH15A
Heat Output	8KW	15KW
UPC	0-84691-86348-9	0-84691-85712-9
With Breaker(s)	45A	30A + 60A

Introduction

UUY(--)ZGDAB Specifications

Outdoor Unit		AUH2436ZGDA		AUH4860ZGDA	
UPC		0-84691-85465-4		0-84691-85469-2	
Capacity Selection		24K	36K	48K	60K
Indoor Unit		UUY24ZGDAB	UUY36ZGDAB	UUY48ZGDAB	UUY60ZGDAB
UPC		0-84691-86343-4	0-84691-86344-1	0-84691-86345-8	0-84691-86346-5
Cooling	Cooling Capacity Btu/hr.	24,000	36,000	48,000	54,000
	SEER	20	18	18	17
	EER	12.5	10	11.5	10.5
	Cooling Operating Range	5-129°F (-15-54°C)		5-129°F (-15-54°C)	
Heating	Heating Capacity Btu/hr.	24,000	36,000	48,000	54,000
	HSPF	10.5	10	10.5	10
	Heating Operating Range	-22-75°F (-30-24°C)		-22-75°F (-30-24°C)	
	Electric Backup Heat Kits	5kW/8kW/10kW		10kW/15kW/20kW	
Indoor Unit	Airflow CFM	960	1000	1380	1600
	Indoor Sound Level dB	47		51	
	Metering Device	TXV		TXV	
	Power Supply	208/230V/1Ph/60Hz		208/230V/1Ph/60Hz	
	Breaker Size A	15		15	
	Maximum Static Pressure W.C.	1.0		1.0	
	Dimension: H x W x D in. (mm)	48 1/4 x 21 1/4 x 21 1/4 (1226 x 540 x 540)		57 x 24 3/4 x 21 1/4 (1448 x 630 x 540)	
	Carton Dimension: H x W x D in. (mm)	50 1/2 x 26 x 23 3/4 (1283 x 660 x 603)		59 3/8 x 27 1/4 x 26 (1508 x 693 x 660)	
	Weight Net/Gross - lbs. (kg)	156.5/169.8 (71/77)		202.8/218.3 (92/99)	
Control	Control Voltage	24VAC		24VAC	
Piping	Refrigerant Type	R410A		R410A	
	Liquid O.D. in.	3/8		3/8	
	Suction O.D. in.	3/4		3/4	
	Piping Connection	BRAZE		BRAZE	
	Factory Charge lbs. (kg)	9.81 (4.45)		9.81 (4.45)	
	Maximum Line Length ft. (m)	164 (50)		164 (50)	
	Maximum Height ft. (m)	50 (15)		50 (15)	

Compatible Electric Heat Kits



AHU #	UUY24ZGDAB / UUY36ZGDAB			UUY48ZGDAB / UUY60ZGDAB	
	UAZEH05A	UAZEH08A	UAZEH10A	UAZEH15A	UAZEH20A
Kit Model #	UAZEH05A	UAZEH08A	UAZEH10A	UAZEH15A	UAZEH20A
Heat Output	5KW	8KW	10KW	15KW	20KW
UPC	0-84691-86347-2	0-84691-86348-9	0-84691-86349-6	0-84691-85712-9	0-84691-85713-6
With Breaker(s)	30A	45A	60A	30A + 60A	60A + 60A

Controls

Operation Modes

Cooling Mode

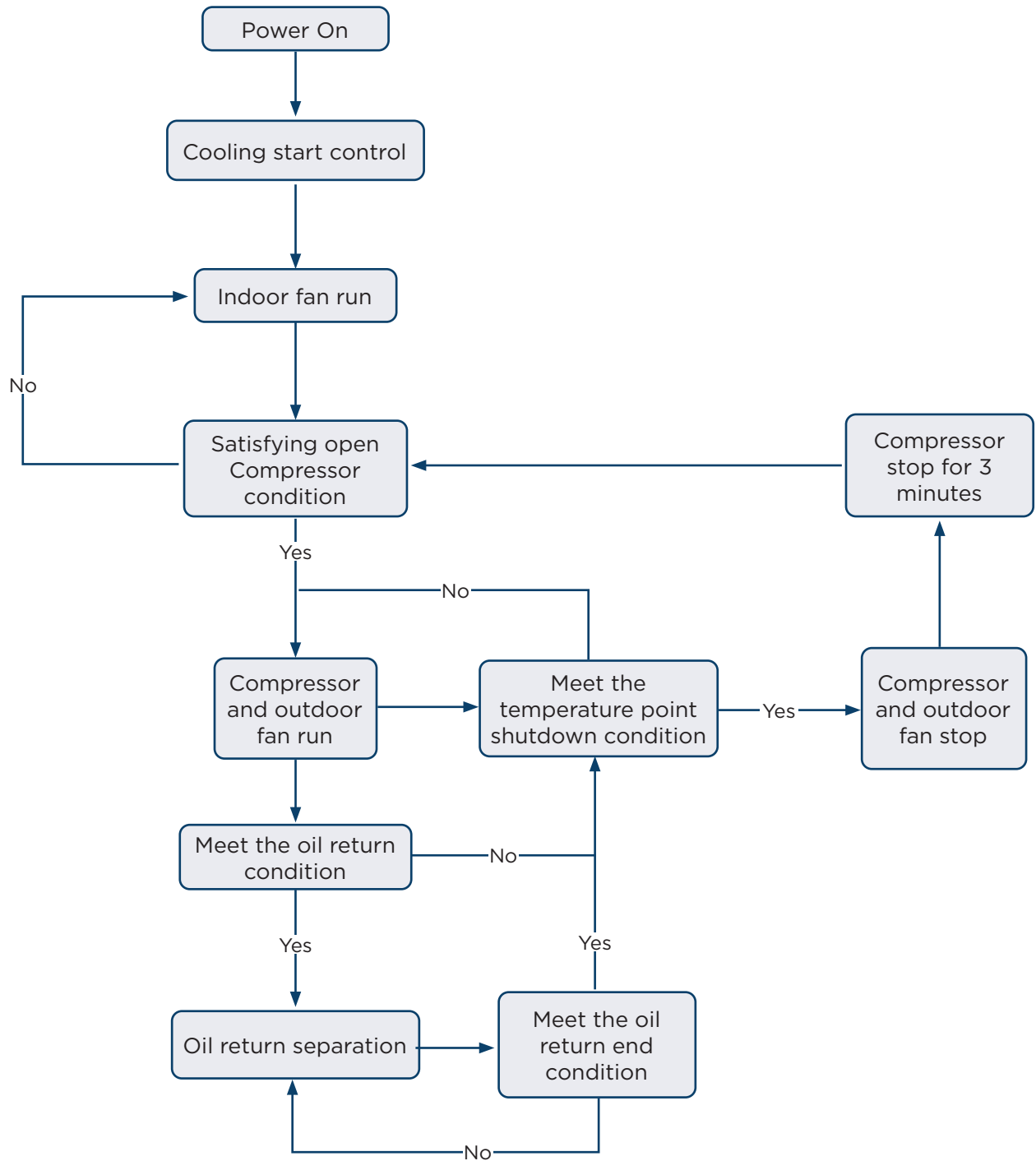

Heating Mode

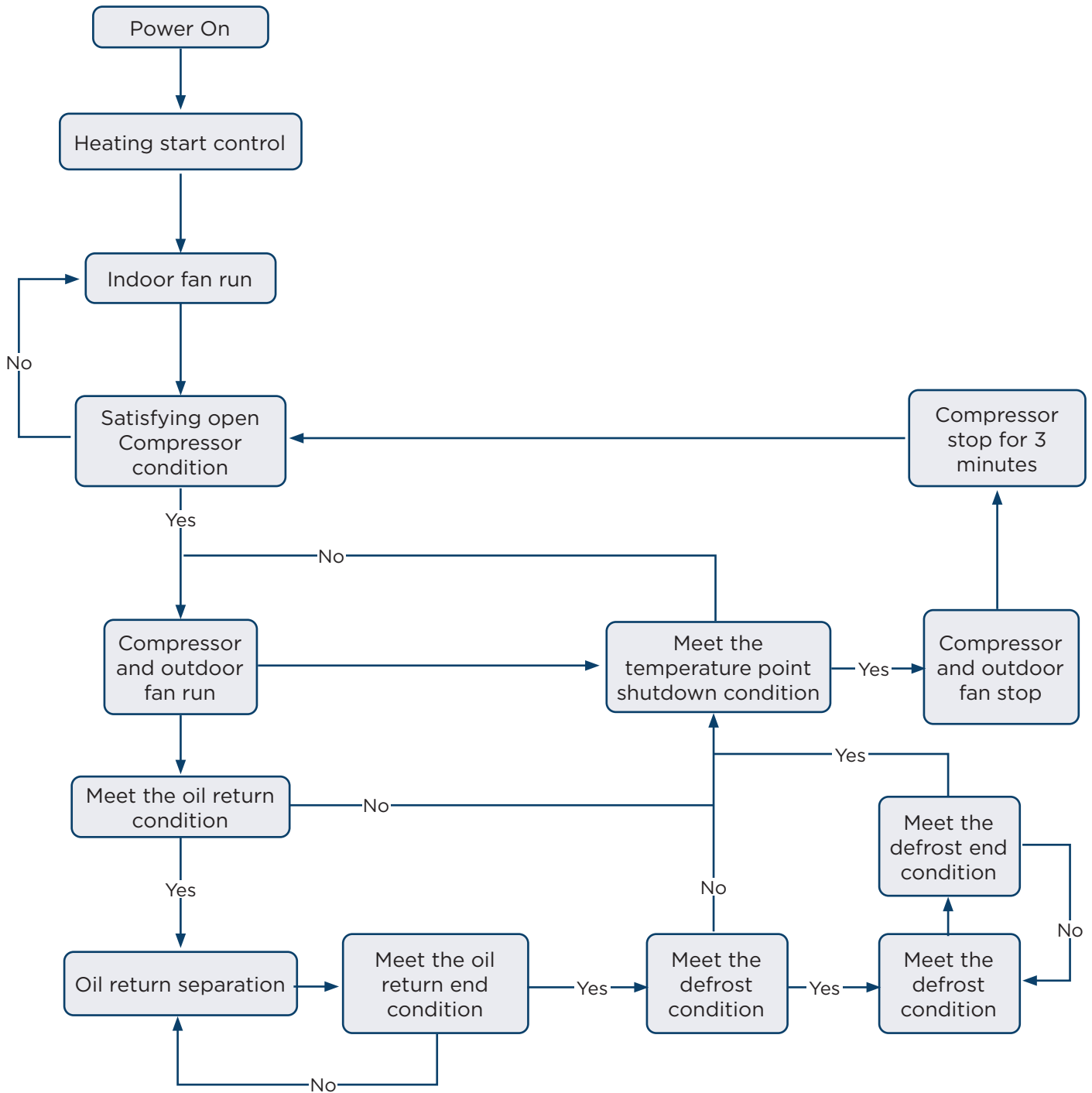

Controls

Control Modes

Based Control

Compressor Control

When the unit comes on in heating or cooling mode; the indoor fan will run for a short time before the compressor starts. Under different modes, the compressor can only be stopped after running for some time (special cases excluded). This is to protect the compressor from short-cycling. Once the compressor has stopped, it cannot be operated right away due to a time delay.

EXV Control

The electric expansion valve will reset when the unit is first started. During the process, the expansion valve will make clicking sounds. The valve will open to a predetermined step before the unit starts in cooling or heating mode.

Outdoor Fan Control

This series heat pump has two types of outdoor units: one with a single fan and the other with dual fans. The outdoor fan can run at the highest level 10 and the lowest level 1. By controlling the speed of outdoor fan, the unit can achieve cooling at low temperature and heating at high temperature. The outdoor unit fan will not run while the system is set to indoor fan mode only.

4-way Valve Control

The 4-way valve will be energized in heat mode (after a brief time delay) on start-up. The 4-way valve will be de energized during cooling and defrost modes.

The 4-way valve will continue to be energized in heating mode after the unit stops. This occurs so the valve will not inadvertently shift into cooling position.

There must be adequate differential pressure for the 4-way valve to function properly.

Special Control

Defrosting Control

Defrosting will start when the temperature sensed by outdoor tube outdoor coil temperature drops below a calculated value. The 4-way valve will switch to the cooling mode and the outdoor fan will stop, but the indoor fan blower will continue running. The defrost cycle will terminate when the outdoor coil temperature reaches the calculated defrost termination value. The 4-way valve will switch back to the heating mode, and the compressor and outdoor fan(s) will restart.

Oil Return Control

The system will enter oil return mode if the compressor has been running at low frequency for an extended period. The system will exit oil return mode in about 5 minutes.

Protection Control

High Pressure Protection Control

The system will shut the compressor down if the high pressure switch is open continuously for a short period of time and display an E1 error code. The compressor will restart after the switch closes for a short period of time. The system will shut the compressor down if the switch opens again within a predetermined time interval. The system will remain in a locked out condition until the power is cycled to the unit.

Controls

Low Pressure Protection Control

The system will shut the compressor down if the low pressure switch opens for a short time and display an E3 error code. The system will automatically restart the compressor when the switch closes after a short time delay. The system will shut the compressor down if the switch subsequently opens again within a predetermined time and will require a power reset to restart.

High Temperature Prevention Control

The system will enable high temperature prevention control while in heating mode if the indoor coil temperature rises above a predetermined threshold. The outdoor fan will slow down during high temperature protection mode.

Discharge High Temperature Protection Control

System will enable discharge temperature protection control if the discharge high temperature sensor is detected open for a predetermined amount of time. The system will shut down and display error code E4 during high temperature protection. The system will restore operation when the discharge temperature drops below the safety threshold. The system will lock out if high discharge temperature is sensed again during a certain time period and power must be reset to the unit.

Functions

Capacity Selection

Set the capacity of the outdoor unit through DIP switch SA2-1 on the outdoor unit main control board.

Outdoor DIP SA2-1																			
AUH2436ZGDA								AUH4860ZGDA											
24K				36K				48K				60K							
On	<input type="checkbox"/>	<input checked="" type="checkbox"/>	<input type="checkbox"/>	<input type="checkbox"/>	On	<input checked="" type="checkbox"/>	<input checked="" type="checkbox"/>	<input type="checkbox"/>	<input type="checkbox"/>	On	<input type="checkbox"/>	<input checked="" type="checkbox"/>	<input type="checkbox"/>	<input type="checkbox"/>	On	<input checked="" type="checkbox"/>	<input checked="" type="checkbox"/>	<input type="checkbox"/>	<input type="checkbox"/>
Off	<input checked="" type="checkbox"/>	<input type="checkbox"/>	<input checked="" type="checkbox"/>	<input checked="" type="checkbox"/>	Off	<input type="checkbox"/>	<input type="checkbox"/>	<input checked="" type="checkbox"/>	<input checked="" type="checkbox"/>	Off	<input checked="" type="checkbox"/>	<input type="checkbox"/>	<input checked="" type="checkbox"/>	<input checked="" type="checkbox"/>	Off	<input type="checkbox"/>	<input type="checkbox"/>	<input checked="" type="checkbox"/>	<input checked="" type="checkbox"/>
	1	2	3	4		1	2	3	4		1	2	3	4		1	2	3	4
■ Indicates switch position																			

Set Defrost Mode

DIP switch SA2-2 on the outdoor unit main control board determines the defrost mode. The following is an example of the defrost setting for a 36k unit. Standard Defrost is default, and Strong Defrost is suitable for defrosting in ultra-low temperature environments.

Outdoor DIP SA2-2									
Standard Defrost (default)					Strong Defrost				
On	<input checked="" type="checkbox"/>	<input checked="" type="checkbox"/>	<input type="checkbox"/>	<input type="checkbox"/>	On	<input checked="" type="checkbox"/>	<input type="checkbox"/>	<input type="checkbox"/>	<input type="checkbox"/>
Off	<input type="checkbox"/>	<input type="checkbox"/>	<input checked="" type="checkbox"/>	<input checked="" type="checkbox"/>	Off	<input type="checkbox"/>	<input checked="" type="checkbox"/>	<input checked="" type="checkbox"/>	<input checked="" type="checkbox"/>
	1	2	3	4		1	2	3	4
■ Indicates switch position									

Controls

Set Operating Mode

DIP switches SA2-3 & SA2-4 on the outdoor unit main control board select the operating mode. The following example shows the 36K outdoor unit. Standard Mode is the default mode.

The heat pump can easily be set to increase the output capacity by adjusting the DIP switches to Strong Mode. The heat pump can also be set to Energy Saving mode if the load is less than expected.

Outdoor DIP SA2-3/SA2-4														
Standard Mode (default)				Strong Mode				Energy Saving Mode						
On	■	■	□	□	On	■	■	■	□	On	■	■	□	■
Off	□	□	■	■	Off	□	□	□	■	Off	□	□	■	□
	1	2	3	4		1	2	3	4		1	2	3	4

■ Indicates switch position

Set Indoor Fan Speed

Set the indoor fan speed through the indoor main control board DIP switches. The higher level, the higher the speed of the indoor unit fan.

	UUY24ZGDAA				UUY36ZGDAA										
	HEAT (Indoor DIP SA2)		COOL (Indoor DIP SA1)		HEAT (Indoor DIP SA2)		COOL (Indoor DIP SA1)								
Level 1 (default)	On	■	□	■	□	On	■	■	■	■	On	■	■	□	■
	Off	□	■	□	■	Off	□	□	■	□	Off	□	□	■	□
		1	2	3	4		1	2	3	4		1	2	3	4
Level 2	On	■	□	□	■	On	■	■	□	□	On	■	■	□	□
	Off	□	■	■	□	Off	□	□	■	■	Off	□	□	■	■
		1	2	3	4		1	2	3	4		1	2	3	4
Level 3	On	■	□	□	□	On	■	□	□	□	On	■	□	■	■
	Off	□	■	■	■	Off	□	■	□	□	Off	□	■	□	□
		1	2	3	4		1	2	3	4		1	2	3	4
	UUY48ZGDAA				UUY60ZGDAA										
	HEAT (Indoor DIP SA2)		COOL (Indoor DIP SA1)		HEAT (Indoor DIP SA2)		COOL (Indoor DIP SA1)								
Level 1 (default)	On	□	■	□	□	On	□	■	■	■	On	□	■	■	■
	Off	■	□	■	■	Off	■	□	□	□	Off	■	□	□	□
		1	2	3	4		1	2	3	4		1	2	3	4
Level 2	On	□	□	■	■	On	□	■	■	□	On	□	■	■	□
	Off	■	■	□	□	Off	■	□	□	■	Off	■	□	□	■
		1	2	3	4		1	2	3	4		1	2	3	4
Level 3	On	□	□	■	□	On	□	■	□	■	On	□	■	□	■
	Off	■	■	□	■	Off	■	■	□	■	Off	■	□	■	□
		1	2	3	4		1	2	3	4		1	2	3	4

■ Indicates switch position

		UUY24ZGDAB UUY48ZGDAB				UUY36ZGDAB UUY60ZGDAB			
		HEAT (Indoor DIP SA2)		COOL (Indoor DIP SA1)		HEAT (Indoor DIP SA2)		COOL (Indoor DIP SA1)	
Level 1	On	<input type="checkbox"/>	<input checked="" type="checkbox"/>	<input checked="" type="checkbox"/>	<input checked="" type="checkbox"/>	<input checked="" type="checkbox"/>	<input checked="" type="checkbox"/>	<input checked="" type="checkbox"/>	<input checked="" type="checkbox"/>
	Off	<input checked="" type="checkbox"/>	<input type="checkbox"/>	<input type="checkbox"/>	<input type="checkbox"/>	<input type="checkbox"/>	<input type="checkbox"/>	<input type="checkbox"/>	<input type="checkbox"/>
		1	2	3	4	1	2	3	4
Level 2 (default)	On	<input type="checkbox"/>	<input checked="" type="checkbox"/>	<input checked="" type="checkbox"/>	<input type="checkbox"/>	<input checked="" type="checkbox"/>	<input checked="" type="checkbox"/>	<input checked="" type="checkbox"/>	<input checked="" type="checkbox"/>
	Off	<input checked="" type="checkbox"/>	<input type="checkbox"/>	<input type="checkbox"/>	<input checked="" type="checkbox"/>	<input type="checkbox"/>	<input type="checkbox"/>	<input type="checkbox"/>	<input checked="" type="checkbox"/>
		1	2	3	4	1	2	3	4
Level 3	On	<input type="checkbox"/>	<input checked="" type="checkbox"/>	<input type="checkbox"/>	<input checked="" type="checkbox"/>	<input checked="" type="checkbox"/>	<input checked="" type="checkbox"/>	<input checked="" type="checkbox"/>	<input checked="" type="checkbox"/>
	Off	<input checked="" type="checkbox"/>	<input type="checkbox"/>	<input checked="" type="checkbox"/>	<input type="checkbox"/>	<input type="checkbox"/>	<input type="checkbox"/>	<input type="checkbox"/>	<input type="checkbox"/>
		1	2	3	4	1	2	3	4
Level 4	On	<input type="checkbox"/>	<input checked="" type="checkbox"/>	<input type="checkbox"/>	<input type="checkbox"/>	<input checked="" type="checkbox"/>	<input checked="" type="checkbox"/>	<input checked="" type="checkbox"/>	<input checked="" type="checkbox"/>
	Off	<input checked="" type="checkbox"/>	<input type="checkbox"/>	<input checked="" type="checkbox"/>	<input checked="" type="checkbox"/>	<input type="checkbox"/>	<input type="checkbox"/>	<input type="checkbox"/>	<input type="checkbox"/>
		1	2	3	4	1	2	3	4
Level 5	On	<input type="checkbox"/>	<input type="checkbox"/>	<input checked="" type="checkbox"/>	<input checked="" type="checkbox"/>	<input checked="" type="checkbox"/>	<input checked="" type="checkbox"/>	<input checked="" type="checkbox"/>	<input checked="" type="checkbox"/>
	Off	<input checked="" type="checkbox"/>	<input checked="" type="checkbox"/>	<input type="checkbox"/>	<input type="checkbox"/>	<input type="checkbox"/>	<input type="checkbox"/>	<input type="checkbox"/>	<input type="checkbox"/>
		1	2	3	4	1	2	3	4
Level 6	On	<input type="checkbox"/>	<input type="checkbox"/>	<input checked="" type="checkbox"/>	<input type="checkbox"/>	<input checked="" type="checkbox"/>	<input checked="" type="checkbox"/>	<input checked="" type="checkbox"/>	<input checked="" type="checkbox"/>
	Off	<input checked="" type="checkbox"/>	<input checked="" type="checkbox"/>	<input type="checkbox"/>	<input checked="" type="checkbox"/>	<input type="checkbox"/>	<input type="checkbox"/>	<input type="checkbox"/>	<input type="checkbox"/>
		1	2	3	4	1	2	3	4
Level 7	On	<input type="checkbox"/>	<input type="checkbox"/>	<input type="checkbox"/>	<input checked="" type="checkbox"/>	<input checked="" type="checkbox"/>	<input checked="" type="checkbox"/>	<input checked="" type="checkbox"/>	<input checked="" type="checkbox"/>
	Off	<input checked="" type="checkbox"/>	<input checked="" type="checkbox"/>	<input checked="" type="checkbox"/>	<input type="checkbox"/>	<input type="checkbox"/>	<input type="checkbox"/>	<input type="checkbox"/>	<input type="checkbox"/>
		1	2	3	4	1	2	3	4
Level 8	On	<input type="checkbox"/>	<input type="checkbox"/>	<input type="checkbox"/>	<input type="checkbox"/>	<input checked="" type="checkbox"/>	<input checked="" type="checkbox"/>	<input checked="" type="checkbox"/>	<input checked="" type="checkbox"/>
	Off	<input checked="" type="checkbox"/>	<input checked="" type="checkbox"/>	<input checked="" type="checkbox"/>	<input checked="" type="checkbox"/>	<input type="checkbox"/>	<input type="checkbox"/>	<input type="checkbox"/>	<input type="checkbox"/>
		1	2	3	4	1	2	3	4

■ Indicates switch position

Controls

Blower Performance Tables

Model	Static Pressure: Inches W.C.	0	0.1	0.15	0.2	0.3	0.4	0.5
UUY24ZGDAA	Speed 1-CFM (L)	1050	940	910	850	720		
	Speed 2-CFM (M)	1200	1070	1010	950	820	630	
	Speed 3-CFM (H)	1280	1180	1130	1080	970	790	660
UUY36ZGDAA	Speed 1-CFM (L)	1230	1100	1000	950	900		
	Speed 2-CFM (M)	1315	1230	1190	1145	1050	900	
	Speed 3-CFM (H)	1430	1325	1275	1225	1120	1050	900
UUY48ZGDAA	Speed 1-CFM (L)	1650	1550	1470	1320	1210		
	Speed 2-CFM (M)	1830	1730	1580	1500	1400	1280	
	Speed 3-CFM (H)	2000	1915	1810	1700	1590	1480	1350
UUY60ZGDAA	Speed 1-CFM (L)	1850	1750	1600	1540	1440		
	Speed 2-CFM (M)	2020	1930	1830	1730	1630	1530	
	Speed 3-CFM (H)	2100	2050	1950	1840	1750	1640	1580

Model	Static Pressure: Inches W.C.	0	0.1	0.15	0.2	0.3	0.4	0.5	0.6	0.7	0.8	0.9	1.0
UUY24ZGDAB	Level 1	1030	900	840	760								
	Level 2	1080	960	900	840	760							
	Level 3		1120	1060	990	850							
	Level 4			1240	1180	1070	960	800					
	Level 5				1390	1290	1180	1090	970	830			
	Level 6					1450	1360	1250	1130	960	800		
	Level 7						1460	1370	1270	1150	970	830	
	Level 8							1500	1410	1340	1200	1080	930
UUY36ZGDAB	Level 1	1150	1050	950	880								
	Level 2	1200	1100	1000	940	850							
	Level 3		1260	1200	1100	950	760						
	Level 4			1390	1310	1160	1010	830					
	Level 5				1560	1480	1400	1310	1210	1080	930		
	Level 6					1640	1590	1500	1420	1330	1220	1100	960
	Level 7						1690	1620	1520	1440	1350	1250	1150
	Level 8							1660	1600	1540	1440	1320	1220
UUY48ZGDAB	Level 1	1640	1500	1450	1400								
	Level 2	1680	1560	1530	1470	1300							
	Level 3		1690	1620	1550	1380							
	Level 4			1770	1710	1580	1430	1280					
	Level 5				1980	1860	1720	1620	1490	1380			
	Level 6					2010	1870	1750	1615	1500	1380		
	Level 7						2080	2000	1880	1750	1600	1420	
	Level 8							2040	1980	1930	1800	1700	1550
UUY60ZGDAB	Level 1	1660	1540	1470	1400								
	Level 2	1850	1720	1650	1600	1400							
	Level 3		1800	1730	1650	1480	1315						
	Level 4			1950	1860	1760	1640	1490	1325				
	Level 5				2140	2040	1930	1800	1670	1520	1370		
	Level 6					2090	2010	1910	1760	1650	1550	1430	1380
	Level 7						2115	2050	1990	1920	1840	1750	1660
	Level 8							2080	2040	2000	1950	1920	1890

Forced Defrost Control

Press and hold the SW1 button for about 5 seconds to enter the first menu level. The outdoor unit main board display will flash. Short-press the SW1 button to switch the function to “06”. Short-press SW2 or SW3 to change the selection within function “06” to “ON”, followed by a short-press on SW1 to save. The menu will time out if no function is performed within 10 seconds.

Refrigerant Recovery Control

Press and hold the SW1 button for about 5 seconds to enter the first menu level. The outdoor unit main board display will flash. Short-press the SW1 button to switch the function to “08”. Short-press SW2 or SW3 to change the selection within function “08” to “ON”, followed by a short-press on SW1 to save. The menu will time out if no function is performed within 10 seconds.

Forced Operation Control

Press and hold the SW1 button for about 5 seconds to enter the first menu level. The outdoor unit main board display will flash. Short-press the SW1 button to switch the function to “09”. Short-press SW2 or SW3 to change the selection within function “09” to “ON”, followed by a short-press on SW1 to save. The menu will time out if no function is performed within 10 seconds.

Thermostat Functions

Please refer to your thermostat user guide for information on your thermostat functions.

Troubleshooting

Wiring Diagrams

The following electric diagram is for reference only. Please refer to diagram attached to the unit as the latest version.

Outdoor Units

Model: AUH2436ZGDA

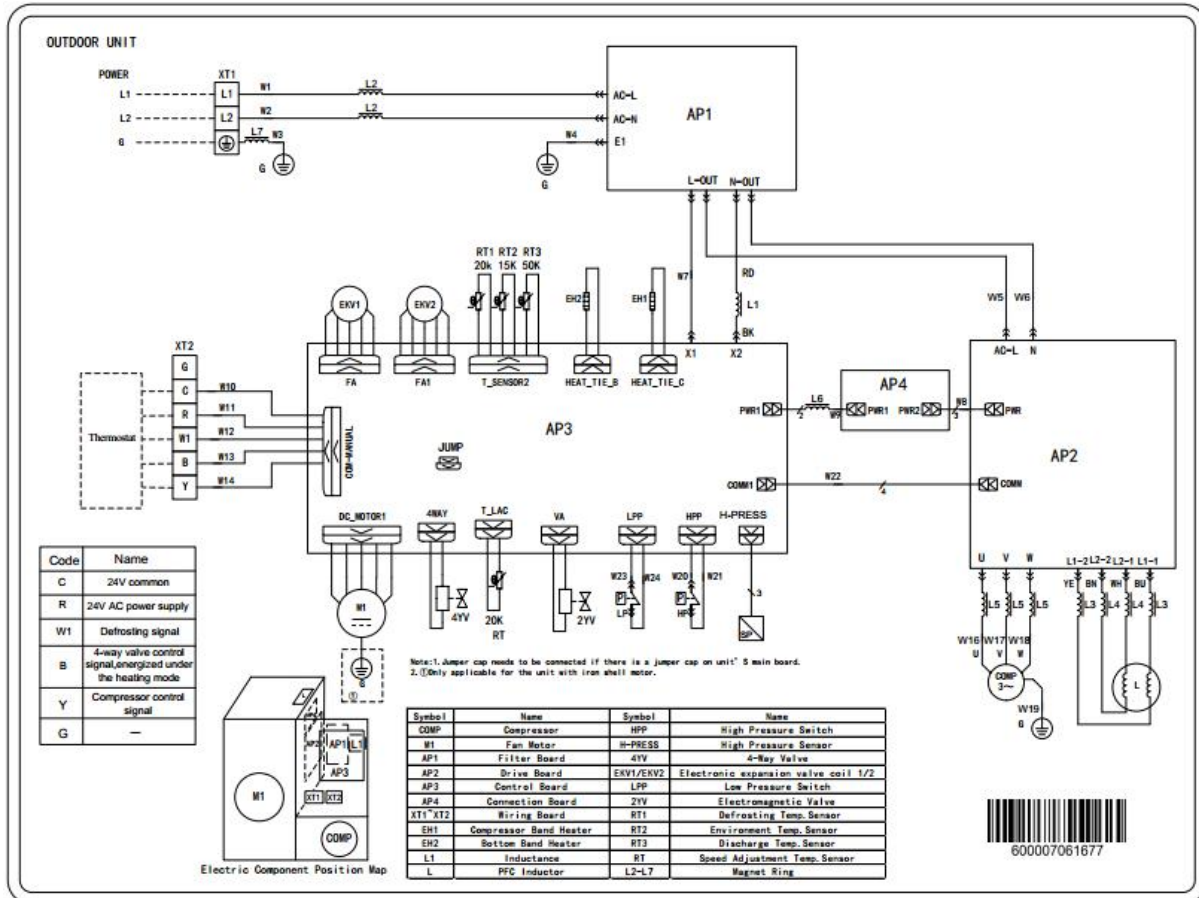

Model: AUH4860ZGDA

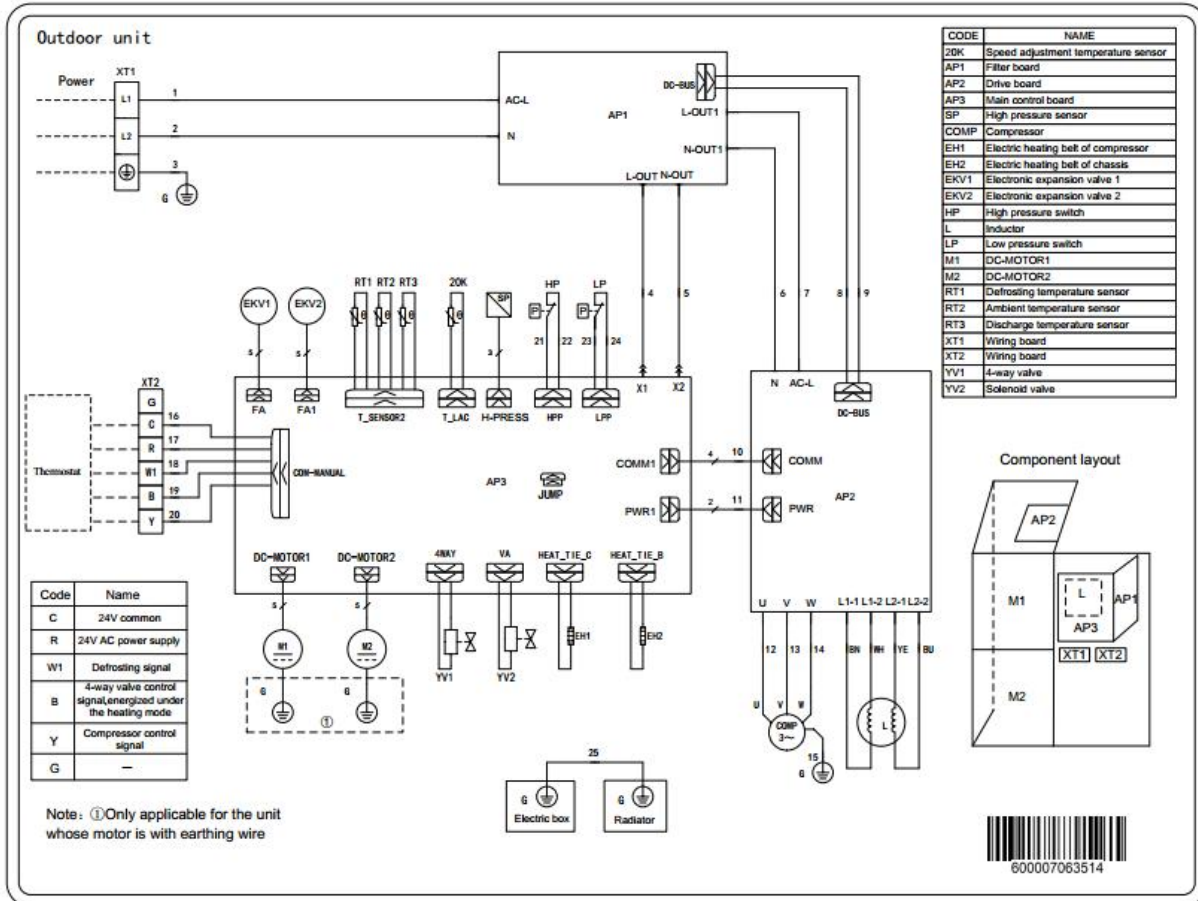

Troubleshooting

Indoor Units

Model: UUY24ZGDAA, UUY36ZGDAA

The following electric diagram is for reference only. Please refer to diagram attached to the unit as the latest version.

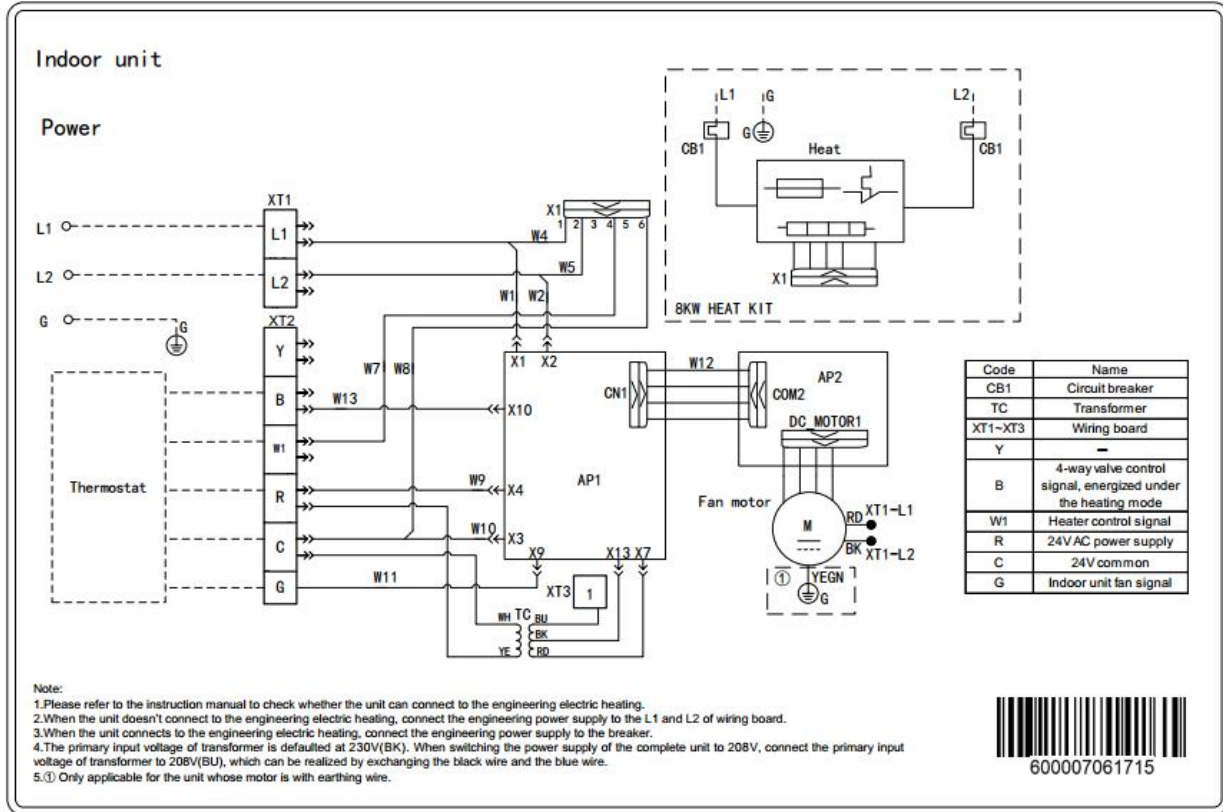

Model: UUY48ZGDAA, UUY60ZGDAA

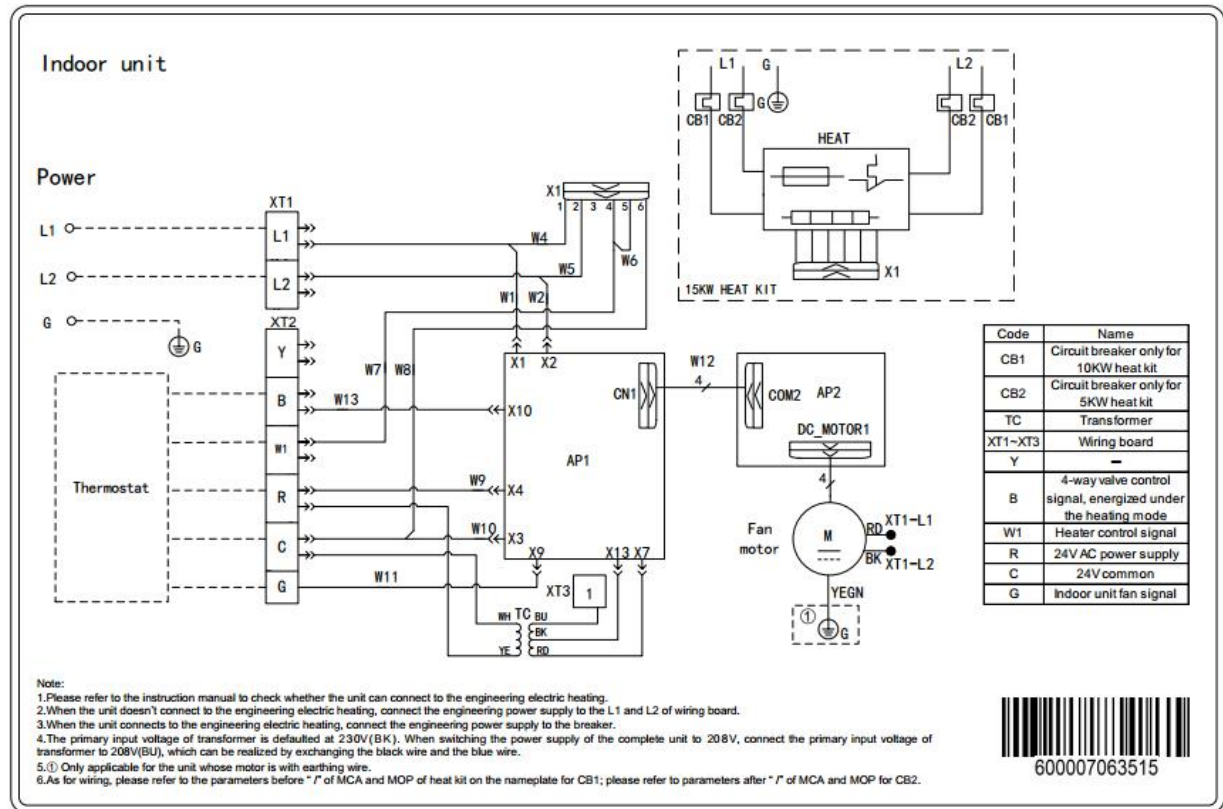

Troubleshooting

Model: UUY24ZGDAB, UUY36ZGDAB

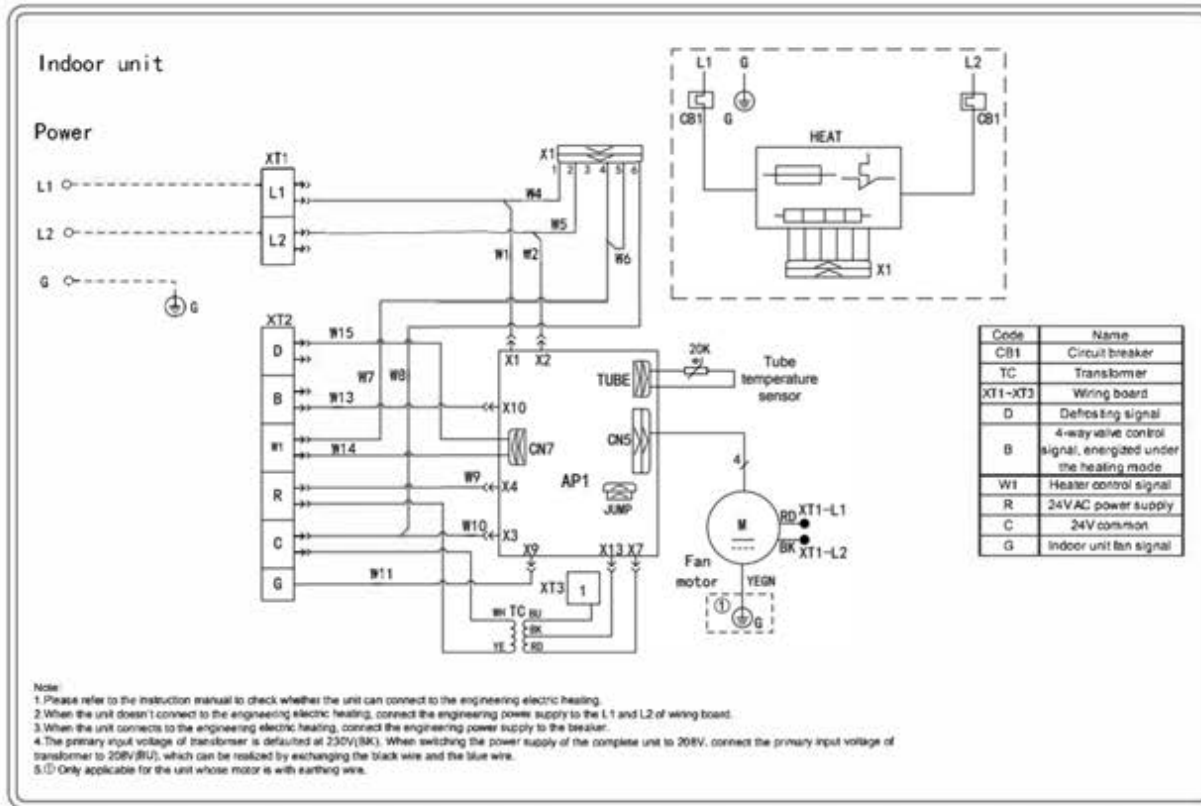

Model: UUY48ZGDAB, UUY60ZGDAB

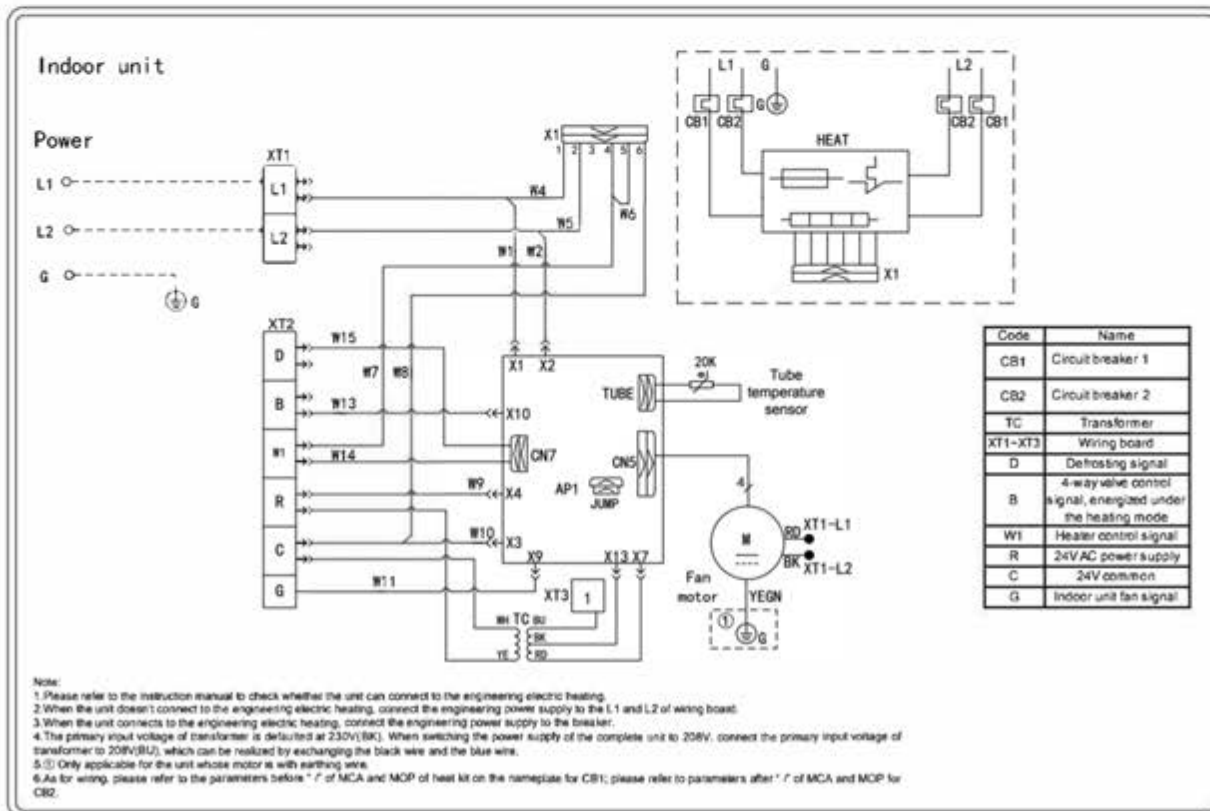

Troubleshooting

PCB Layout

Interface

Indoor Unit:

Model: UUY24ZGDAA, UUY36ZGDAA, UUY48ZGDAA, UUY60ZGDAA

Main Board

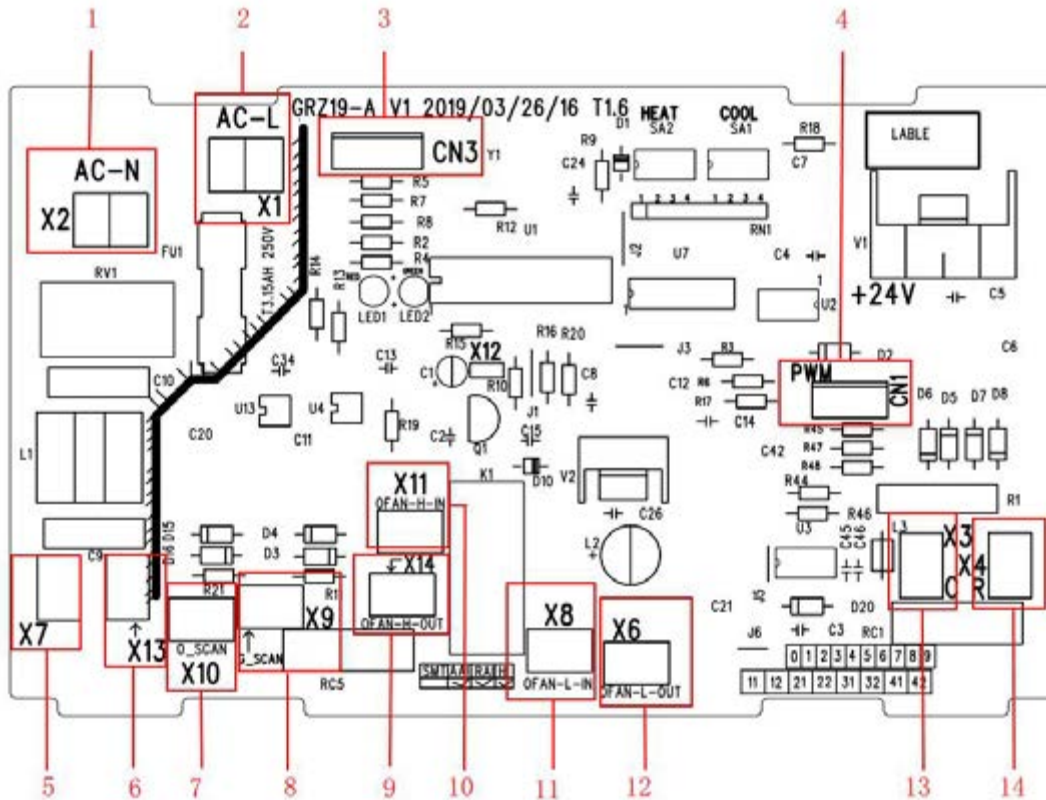

No.	Printing	Interface	No.	Printing	Interface
1	AC-N (X2)	Neutral wire input	8	X9 (G_SCAN)	Indoor motor check
2	AC-L (X1)	Live wire input	9	X14 (OFAN-H-OUT)	AC motor high speed output
3	CN3	Wired control communication interface	10	X11 (OFAN-H-IN)	AC motor high speed input
4	CN1	DC motor output	11	X8 (OFAN-L-IN)	AC motor low speed input
5	X7	Transformer Neutral wire input	12	X6(OFAN-L-OUT)	AC motor low speed output
6	X13	Transformer Live wire input	13	X3 (C)	Transformer Neutral wire output
7	X10 (O_SCAN)	4-Way check	14	X4 (R)	Transformer Live wire output

Troubleshooting

Motor Board

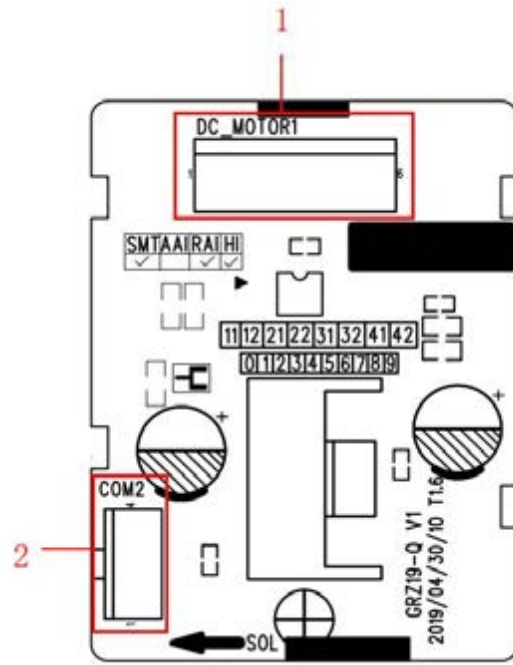

No.	Printing	Interface	No.	Printing	Interface
1	DC-MOTOR1	DC motor output	2	COM2	DC motor control signal input

Troubleshooting

Indoor Unit

Models: UUY24ZGDAB, UUY36ZGDAB, UUY48ZGDAB, UUY60ZGDAB

Main Board

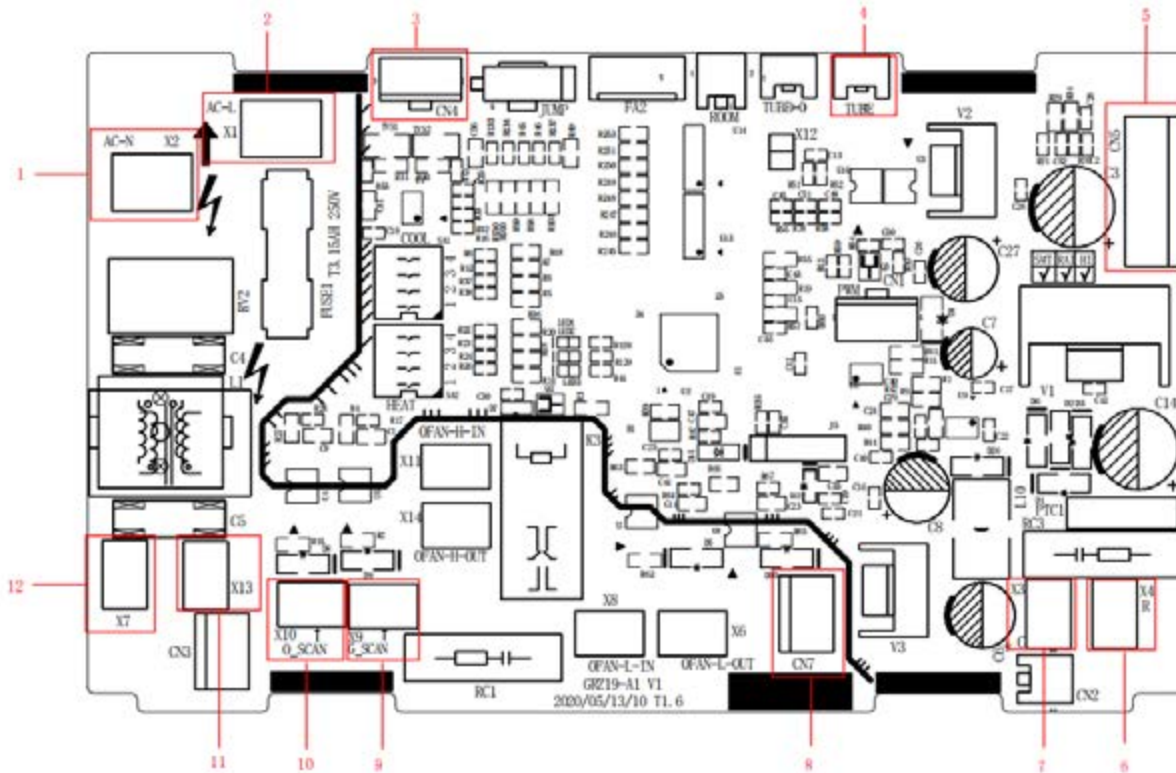

No.	Printing	Interface	No.	Printing	Interface
1	AC-N (X2)	Neutral wire input	7	X3 (C)	Transformer Neutral wire output
2	AC-L (X1)	Live wire input	8	CN7	1. Electrical heat check 3. Defrosting check
3	CN4	Wired control communication interface	9	X9 (G_SCAN)	Indoor motor check
4	TUBE	Tube temperature sensor interface	10	X10 (O_SCAN)	4-Way check
5	CN5	DC motor output	11	X13	Transformer Live wire input
6	X4 (R)	Transformer Live wire output	12	X7	Transformer Neutral wire input

Troubleshooting

Outdoor Unit:
Model: AUH2436ZGDA, AUH4860ZGDA

Main Board

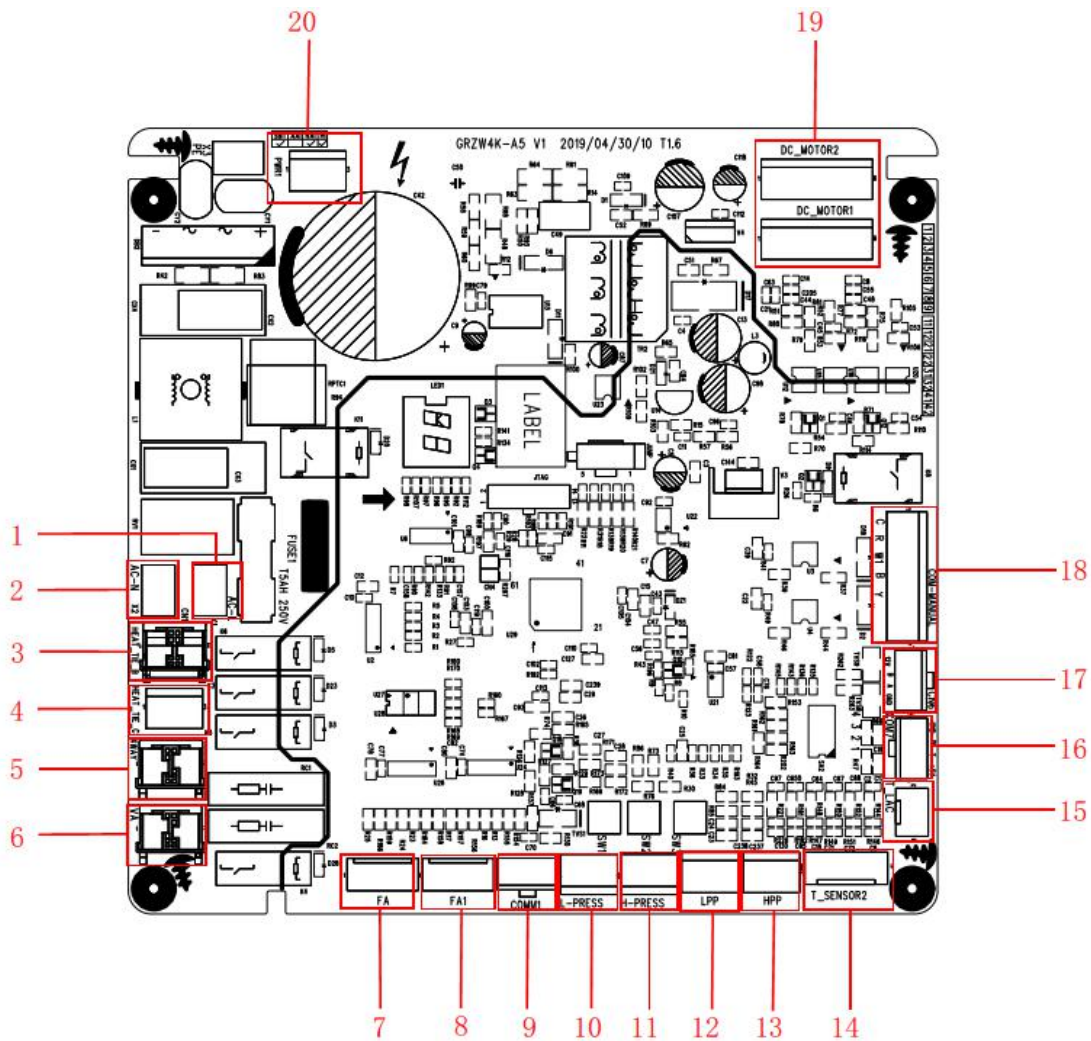

No.	Printing	Interface	No.	Printing	Interface
1	AC-L	Live wire input	11	H-PRESS	High pressure sensor interface
2	AC-N	Neutral wire input	12	LPP	System low pressure protection interface
3	HEAT_TIE_B	Chassis electric heating belt	13	HPP	System high pressure protection interface
4	HEAT_TIE_C	Compressor electric heating belt	14	T_SENSOR2	2. Outdoor tube temperature sensor interface 4. Outdoor ambient temperature sensor interface 6. Discharge temperature sensor interface
5	4WAY	4-way valve	15	T_LAC	Low temperature cooling temperature sensing
6	VA	Electromagnetic valve interface	16	COM7	Unit communication interface
7	FA	Electronic expansion valve interface	17	CN6	GPRS communication interface
8	FA1	Electronic expansion valve 1 interface Refrigerant heat dissipation	18	COM-MANUAL	Thermostat interface
9	COMM1	Drive communication interface	19	DC_MOTOR1 DC_MOTOR2	DC motor output
10	L-PRESS	Low pressure sensor interface	20	PWR1	310V DC power supply interface

Troubleshooting

Drive Board

Model: AUH2436ZGDA

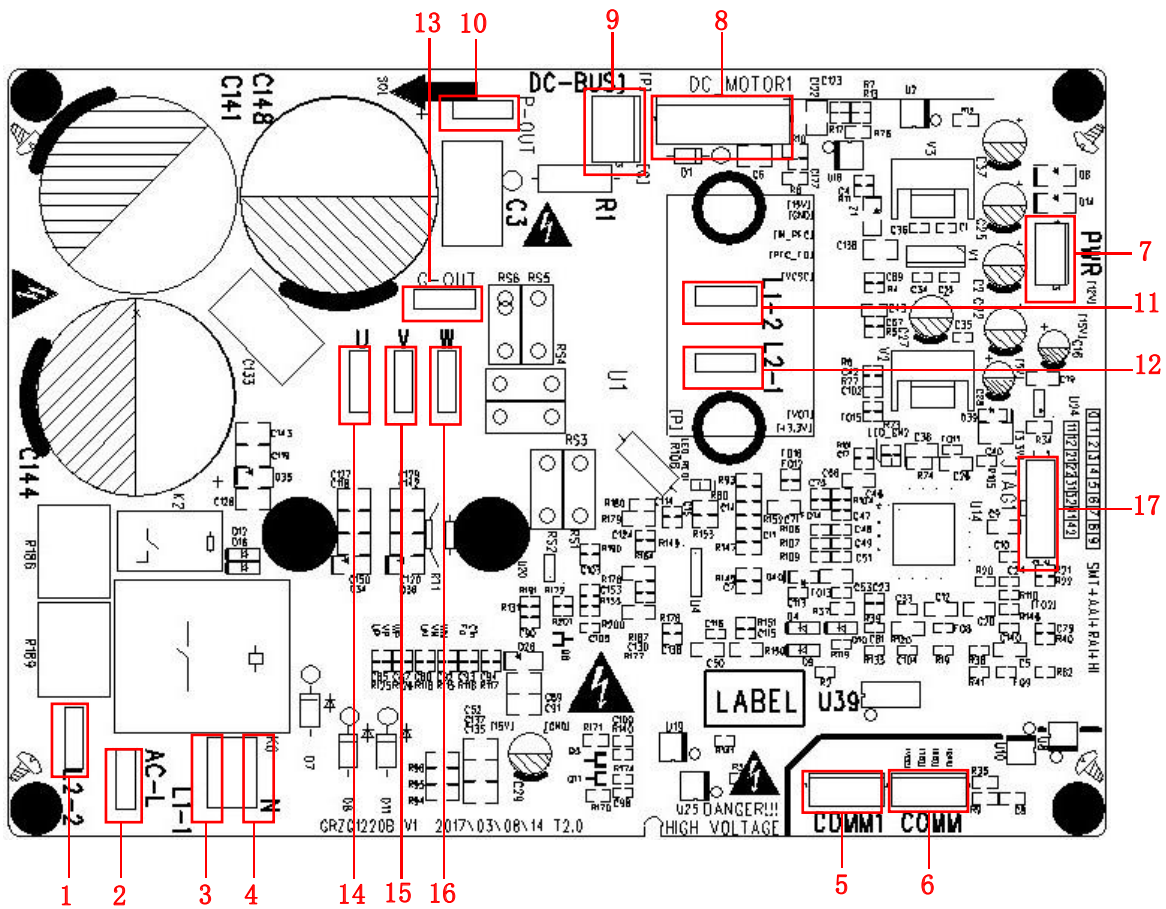

No.	Printing	Interface	No.	Printing	Interface
1	L2-2	PFC induction wire (blue)	10	P-OUT	Reserved
2	AC-L	Live wire	11	L1-2	PFC induction wire (white)
3	L1-1	PFC induction wire (brown)	12	L2-1	PFC induction wire (yellow)
4	N	Neutral wire	13	G-OUT	Reserved
5	COMM1	Communication terminal, same with COMM	14	U	Compressor U phase terminal
6	COMM	Communication terminal, same with COMM1	15	V	Compressor V phase terminal
7	PWR	Drive power supply terminal	16	W	Compressor W phase terminal
8	DC-MOTOR1	DC fan terminal	17	JTAG1	Programming interface (for testing)
9	DC-BUS1	Power discharge terminal (for testing)			

Troubleshooting

Model: AUH4860ZGDA

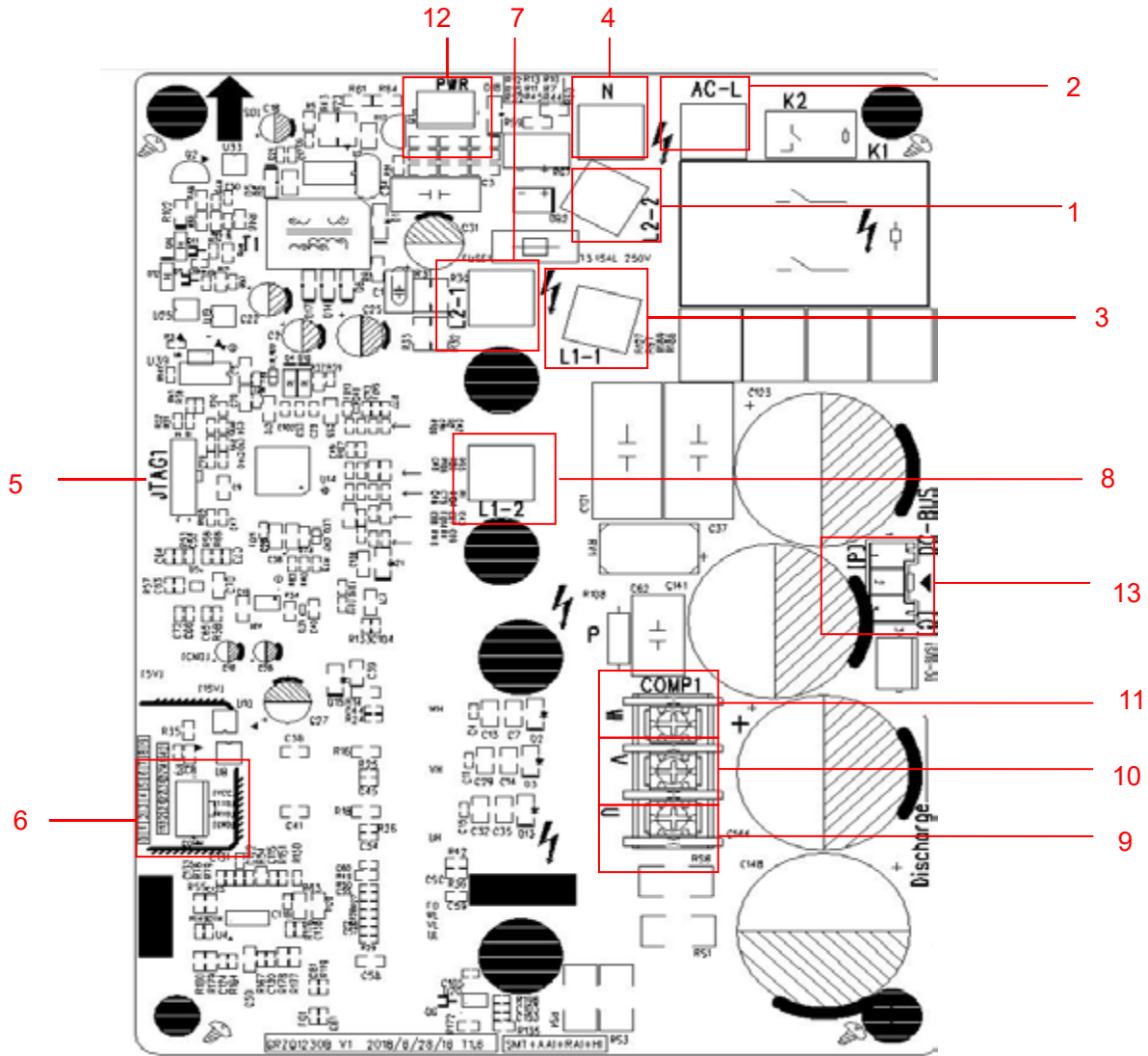

No.	Printing	Interface	No.	Printing	Interface
1	L2-2	PFC induction wire (blue)	8	L1-2	PFC induction wire (white)
2	AC-L	Live wire	9	U	Compressor U phase terminal
3	L1-1	PFC induction wire (brown)	10	V	Compressor V phase terminal
4	N	Neutral wire	11	W	Compressor W phase terminal
5	JTAG1	Programming interface (for testing)	12	PWR	Drive power supply terminal
6	COMM	Communication terminal, same with COMM	13	DC-BUS	Power discharge terminal (for testing)
7	L2-1	PFC induction wire (yellow)			

Troubleshooting

Filtering Board

Model: AUH2436ZGDA

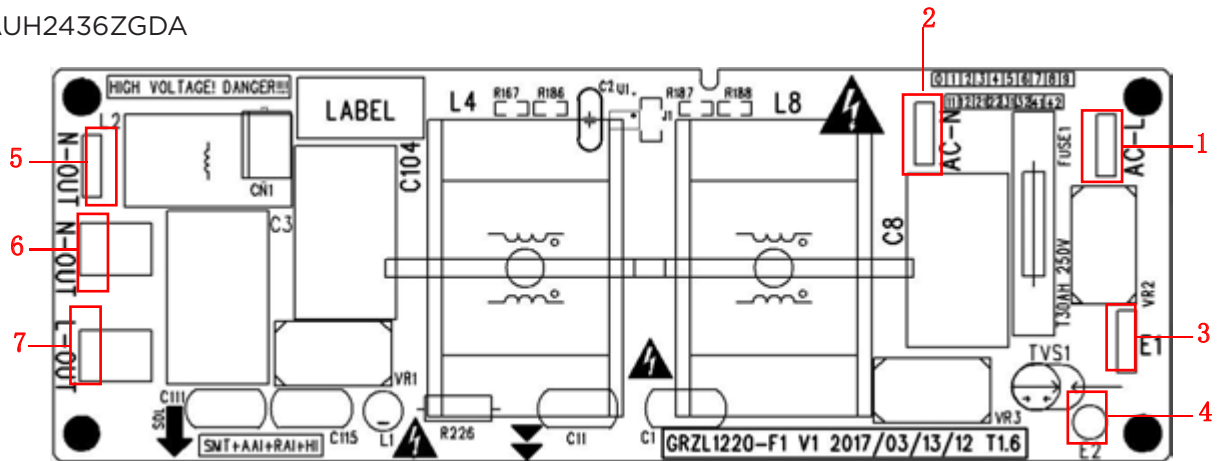

No.	Printing	Interface	No.	Printing	Interface
1	AC-L	Power input live wire terminal	5	N-OUT	Power output neutral wire terminal (reserved)
2	AC-N	Power input neutral wire terminal	6	N-OUT	Power output neutral wire terminal
3	E1	Filtering board ground wire terminal	7	L-OUT	Power output live wire terminal
4	E2	Filtering board grounding hole (reserved)			

Model: AUH4860ZGDA

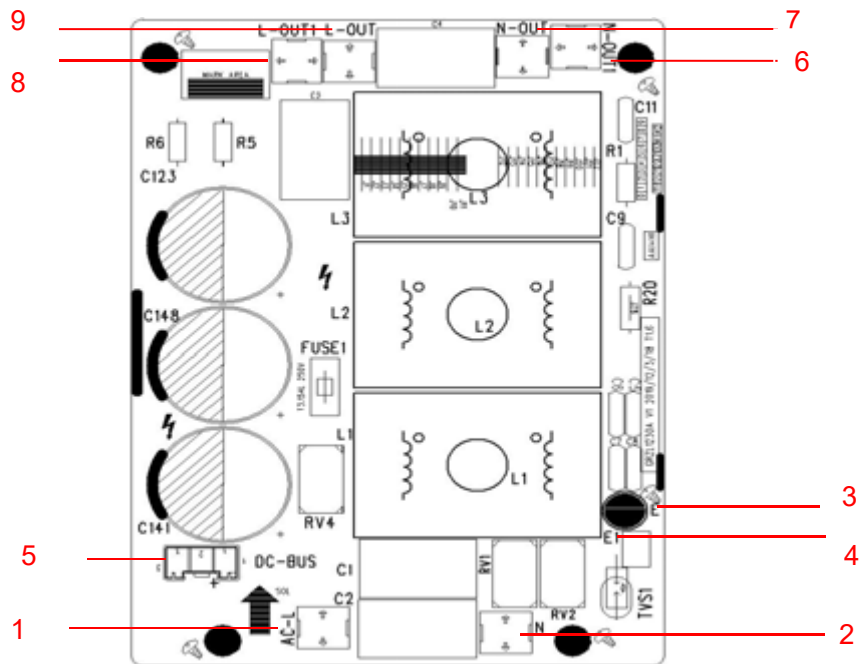

No.	Printing	Interface	No.	Printing	Interface
1	AC-L	Power input live wire terminal	6	N-OUT1	Power output neutral wire terminal (reserved)
2	N	Power input neutral wire terminal	7	N-OUT	Power output neutral wire terminal
3	E	Filtering board ground wire terminal	8	L-OUT1	Power output live wire terminal
4	E1	Filtering board grounding hole (reserved)	9	L-OUT	Power output live wire terminal
5	DC-BUS	Power discharge terminal (for testing)			

Troubleshooting

IPM, PFC Testing Method

Method of Testing IPM Module

- Turn off power to the outdoor unit for at least one minute. Set a multi meter to diode test function. Remove the U, V and W wires from the compressor.

Testing Steps

1. Place the black meter lead on the “P” terminal and place the red meter lead on U, V and W respectively to measure voltage between UP, VP and WP.
2. Please the red meter lead on the “N” terminal and the black meter lead on U, V, and W respectively to measure voltage between NU, NV and NW.
3. A good IPM board is indicated by reading 0.3 to 0.7 volts between UP, VP, WP, NU, NV and NW.
4. A bad board is indicated by a zero reading in any of the measurements.

Method of Testing PFC Module Short Circuit

- Turn off power to the outdoor unit and wait at least one minute. Set a multi meter to diode test. Remove wires from L1-2, and L2-1.

Testing Steps:

1. Place the black lead on terminal P and the read lead on terminal L1-2 and L2-1 respectively. Measure the voltages between L1-2 and P; L2-1 and P.
2. Place the red lead on terminal N and the black lead on L1-2 and L2-1 respectively. Measure the voltage between N and L1-2 and N and L2-1.
3. Voltages between 0.3 and 0.7 volts indicate a normal PFC module. Any zero volt measurement indicates a failed module.

AUH2436ZGDAA

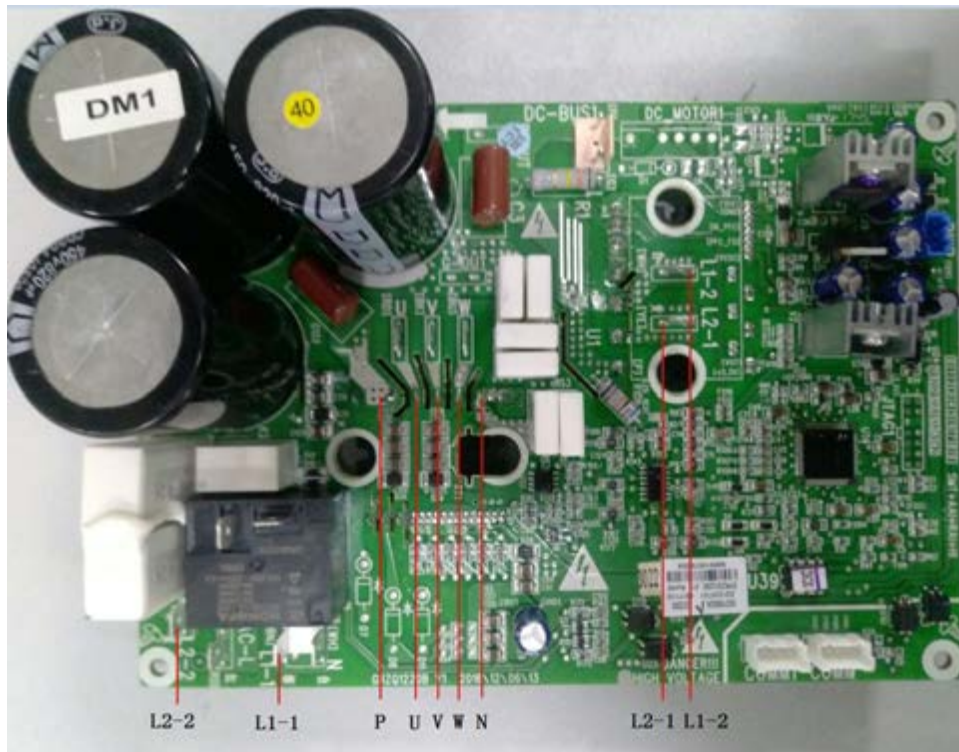

Troubleshooting

AUH4860ZGDAA

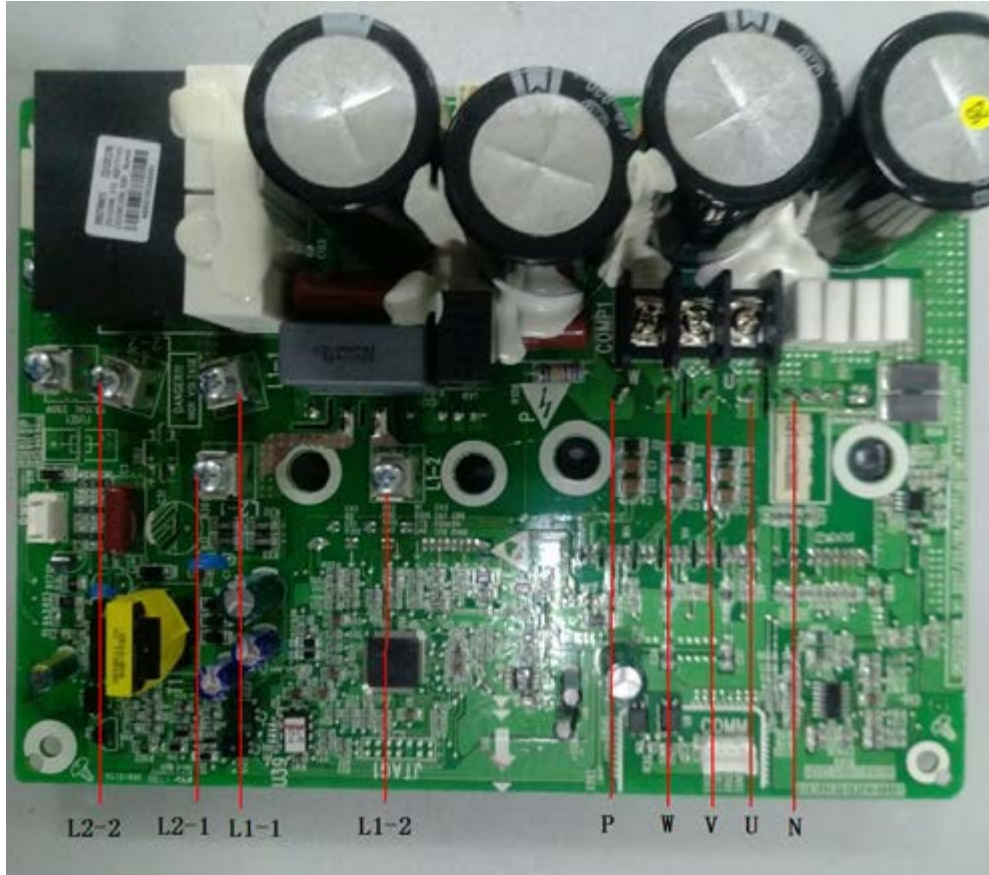

Indoor Unit LED Indicators (UUY(--))ZGDAB Only)

There are LED indicators on the main board of the indoor unit, which are used to display the operating status and malfunction information of the unit.

LED indicator	Color	Function
Power Indicator	Red	Indoor unit main board is powered on, Power Indicator is on.
Running Indicator	Green	After detecting the indoor fan turn-on signal, the running indicator light is on, when detecting the indoor fan turning-off signal, the running indicator light is off. When detecting a system failure, the running indicator light flashes.

Malfunction	Running Indicator Status	Remark
Indoor Jumper Cap failure	Light out 3S then flash once	Flash means light on 0.5S then light out 0.5S
Indoor Fan failure	Light out 3S then flash twice	
Indoor Tube Temperature Sensor failure	Light out 3S then flash four times	

Outdoor Unit Error Codes

The outdoor unit main board LED will display an error code identifying a malfunction of the unit if present.

No.	Error code	Error
1	E1	Compressor high pressure protection
2	E3	Compressor low pressure protection
3	E4	Compressor air discharge high-temperature protection
4	F2	Condenser temperature sensor error
5	F3	Outdoor ambient temperature sensor error
6	F4	Discharge temperature sensor error
7	F6	ODU tube temperature sensor error
8	EE	ODU memory chip error
9	H4	Overload
10	H5	IPM protection
11	H6	DC fan error
12	H7	Driver out-of-step protection
13	HC	PFC protection
14	Lc	Startup failure
15	P0	Driver reset protection
16	P5	Over-current protection
17	P6	Master control and driver communication error
18	P7	Driver module sensor error
19	P8	Driver module high temperature protection
20	PA	AC current protection
21	Pc	Driver current error
22	PL	Bus low-voltage protection
23	PH	Bus high-voltage protection
24	PU	Charge loop error
25	ee	Drive memory chip error
26	e1	High pressure sensor error
27	C4	ODU jumper cap error

Troubleshooting

Troubleshooting

“E1” Compressor High Pressure Protection

Error display:

ODU main board LED display

Error judgment condition and method:

It is judged through the action of high pressure switch. If the high pressure switch is cut off, it is judged that high pressure is too high and the system stops operation for protection.

Possible causes:

- Cut-off valve of ODU is not fully opened
- High pressure switch is abnormal
- Outdoor or indoor fan is not working properly
- IDU filter or air duct is blocked (heating mode)
- Ambient temperature is too high
- System is overcharged
- Refrigerant line set is blocked

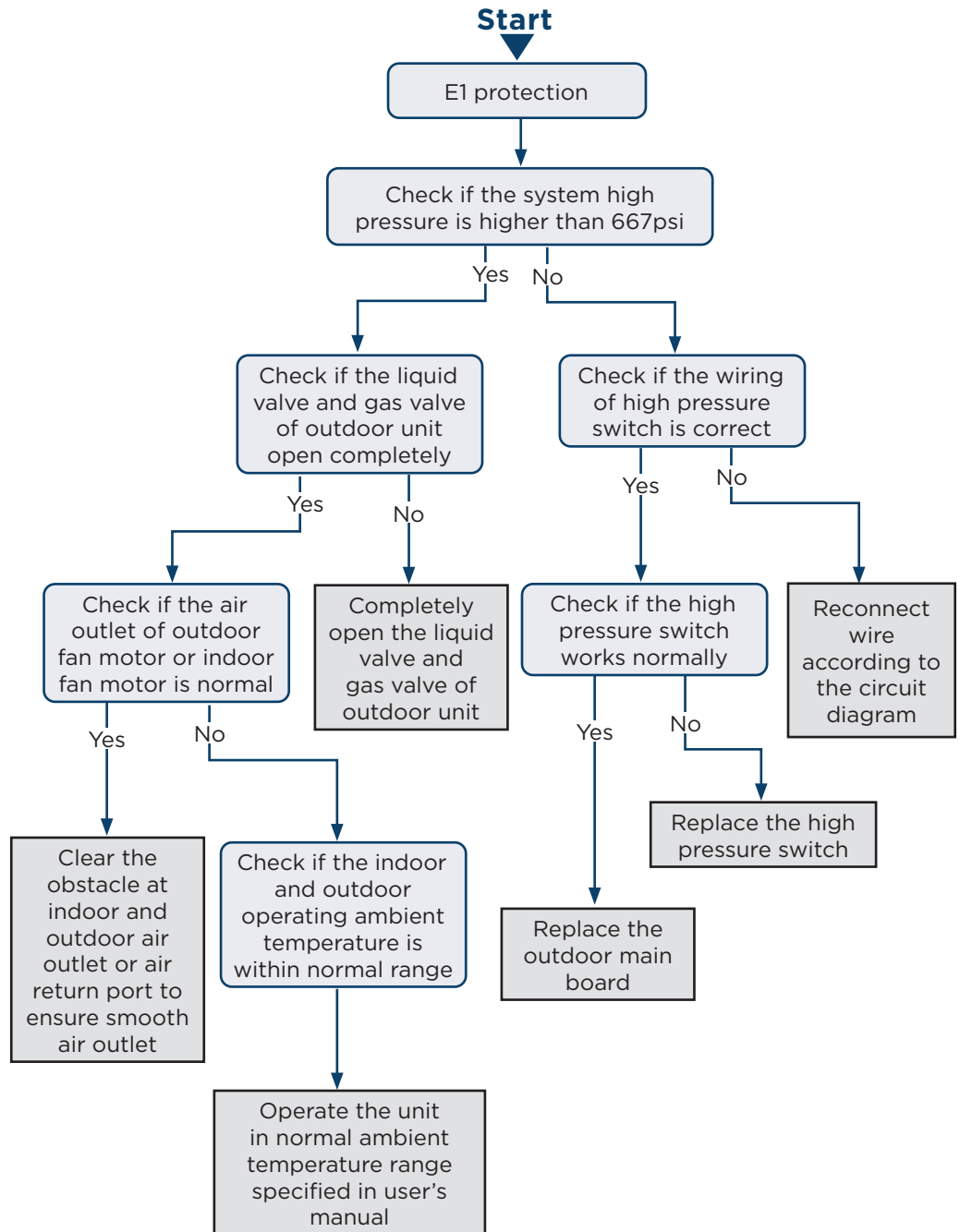

“E3” Compressor Low-Pressure Protection, Refrigerant Undercharge Protection, Refrigerant Recovery Mode

Error display:

ODU main board LED display

Error judgment condition and method:

It is judged through the action of low pressure switch. If the low pressure switch is cut off, it is judged that low pressure is too low and the system stops operation for protection.

Possible causes:

- Service valve of ODU is not fully opened
- Low pressure sensor is abnormal
- Outdoor or indoor fan is not working properly
- IDU filter or air duct is blocked (cooling mode)
- Ambient temperature is too low
- System is undercharged
- Refrigerant line set is blocked

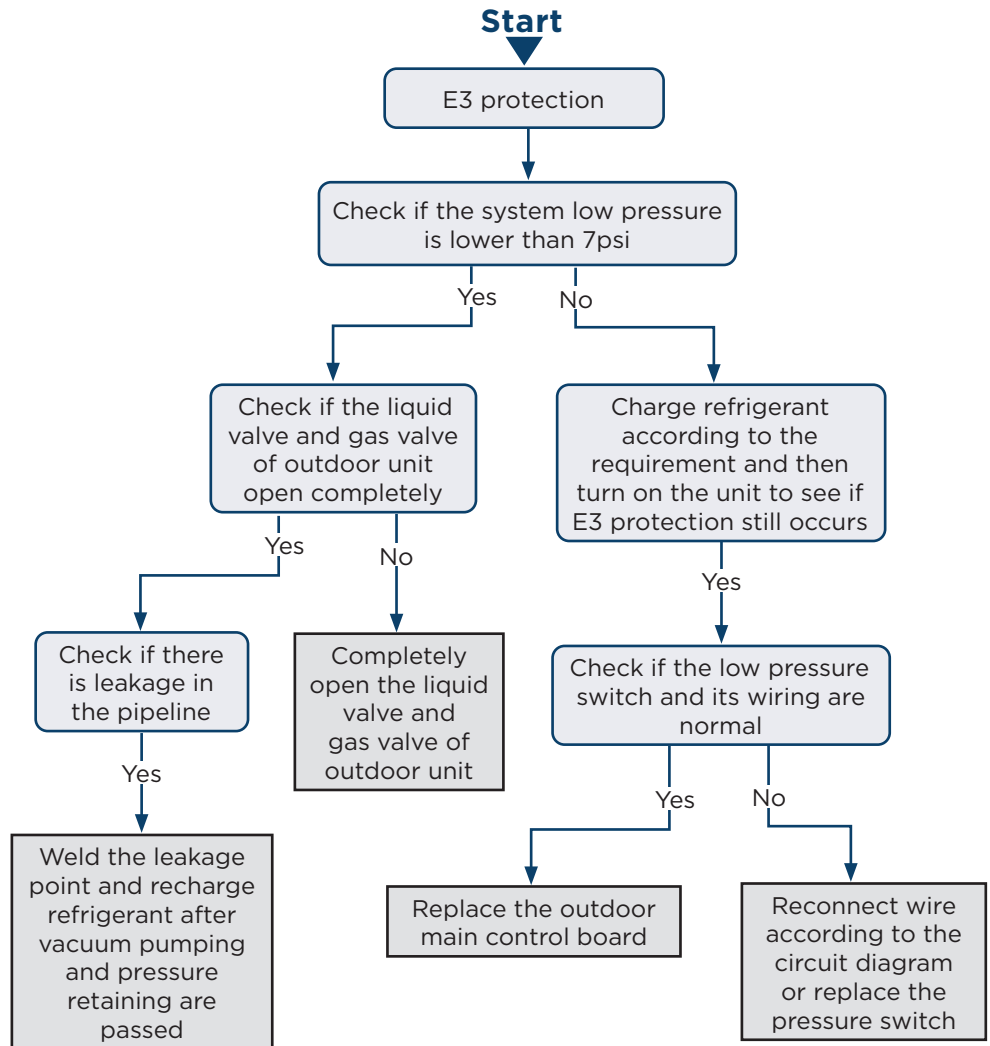

Troubleshooting

“E4” Compressor Air Discharge High-Temperature Protection

Error display:

ODU main board LED display

Error judgment condition and method:

Test the compressor discharge temperature through compressor discharge pipe and compressor shell top temperature sensor. If the tested temperature value is higher than 239°F, the unit will stop for protection.

Possible causes:

- Service valve of ODU is not fully opened
- Electronic expansion valve is abnormal
- Outdoor or indoor fan is not working properly
- IDU filter or air duct is blocked (cooling mode)
- Ambient temperature exceeds allowable operation range
- System is under charged
- Refrigerant lines are blocked

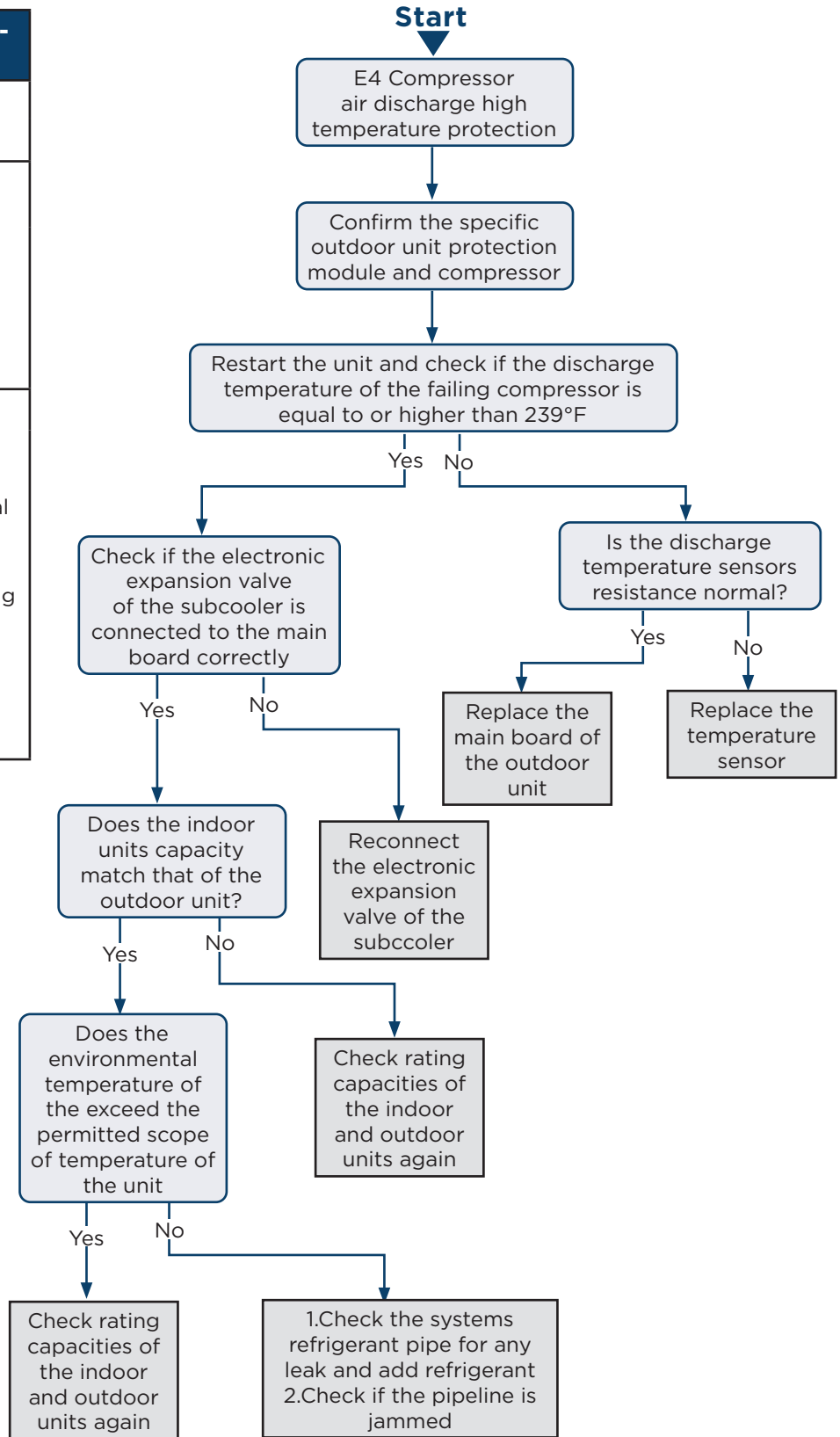

“F2” Condenser Temperature Sensor Error

Error display:

ODU main board LED display

Error judgment condition and method:

Sample the AD value of temperature sensor through temperature sensor detecting circuit and judge the range of AD value, If the sampling AD value exceeds upper limit and lower limit in 5 seconds continuously, report the error.

Possible causes:

- Poor contact between temperature sensor and terminal in main board interface
- Temperature sensor is abnormal
- Detecting circuit is abnormal

Note: Please refer to Appendix 1 for the relation between temperature and resistance of temperature sensor.

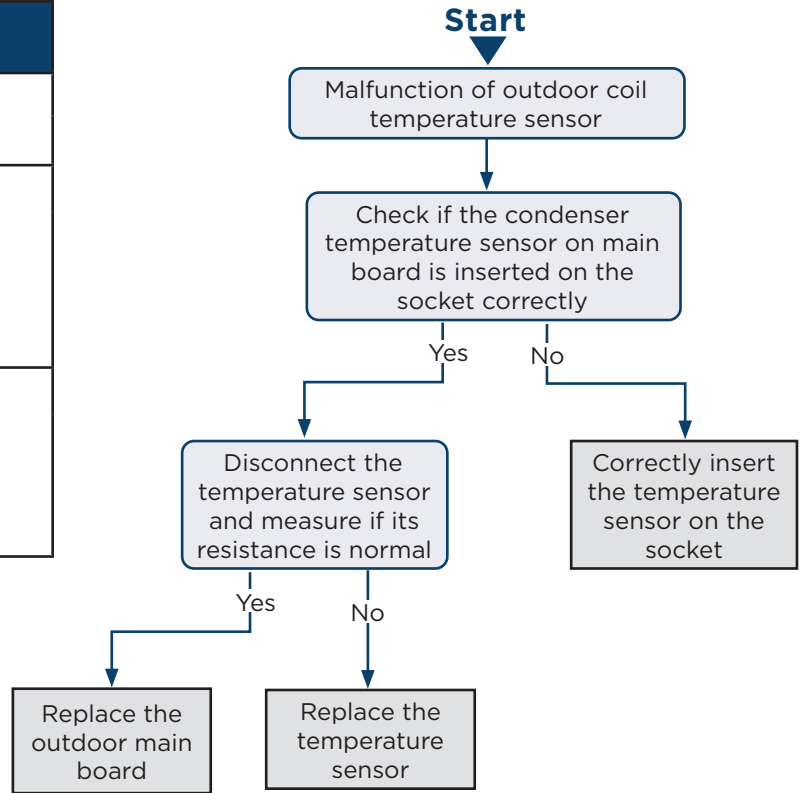

“F3” Outdoor Ambient Temperature Sensor Error

Error display:

ODU main board LED display

Error judgment condition and method:

Sample the AD value of temperature sensor through temperature sensor detecting circuit and judge the range of AD value, If the sampling AD value exceeds upper limit and lower limit in 5 seconds continuously, report the error.

Possible causes:

- Poor contact between ambient temperature sensor and terminal in main board interface
- Ambient temperature sensor is abnormal
- Detecting circuit is abnormal

Note: Please refer to Appendix 1 for the relation between temperature and resistance of temperature sensor.

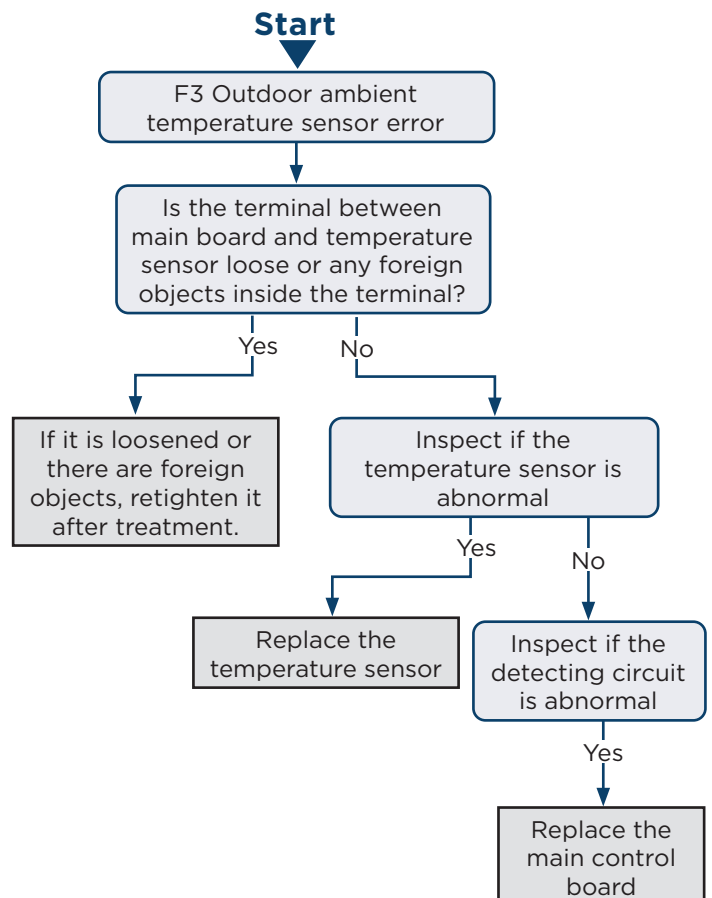

Troubleshooting

“F4” Discharge Temperature Sensor Error
Error display: ODU main board LED display
Error judgment condition and method: Sample the AD value of temperature sensor through temperature sensor detecting circuit and judge the range of AD value, If the sampling AD value exceeds upper limit and lower limit in 5 seconds continuously, report the error.
Possible causes: <ul style="list-style-type: none"> Poor contact between temperature sensor and terminal in main board interface Temperature sensor is abnormal Detecting circuit is abnormal

Note: Please refer to Appendix 1 for the relation between temperature and resistance of temperature sensor.

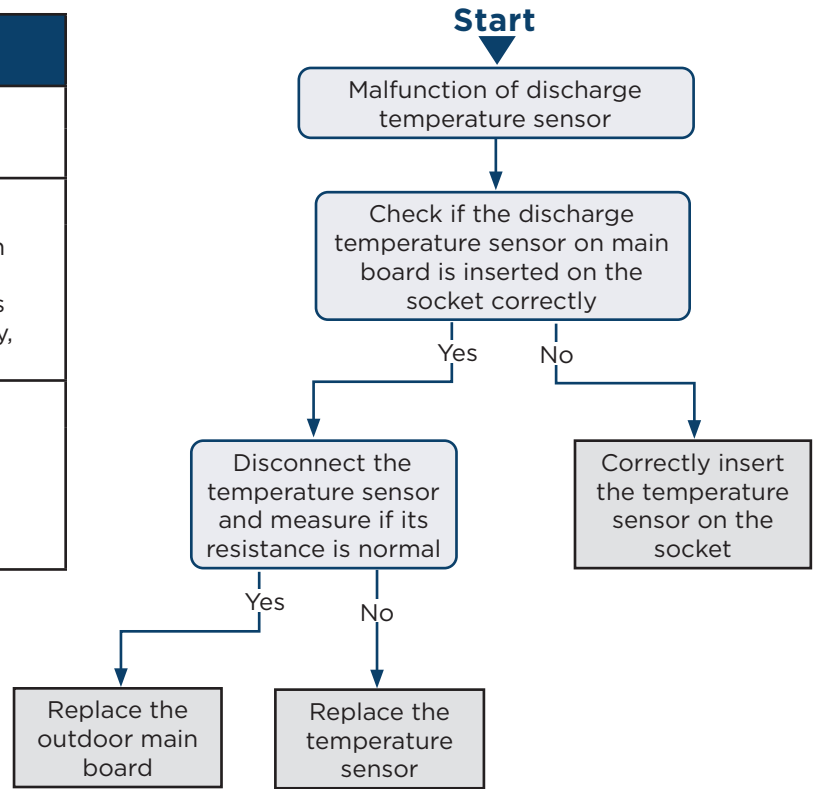

“F6” ODU Tube Temperature Sensor Error
Error display: ODU main board LED display
Error judgment condition and method: Sample the AD value of temperature sensor through temperature sensor detecting circuit and judge the range of AD value, If the sampling AD value exceeds upper limit and lower limit in 5 seconds continuously, report the error.
Possible causes: <ul style="list-style-type: none"> Poor contact between temperature sensor and terminal in main board interface Temperature sensor is abnormal Detecting circuit is abnormal

Note: Please refer to Appendix 1 for the relation between temperature and resistance of temperature sensor.

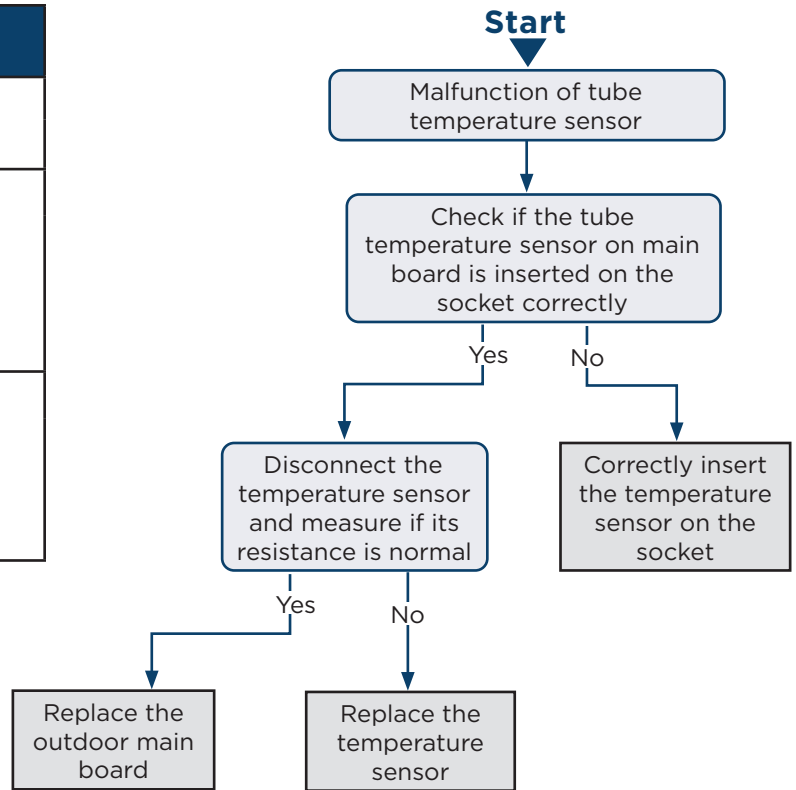

“EE” ODU Memory Chip Error

Error display:

ODU main board LED display

Error judgment condition and method:

If ODU main board cannot read the memory chip, this error will be reported.

Possible causes:

- Memory chip on the ODU main board is damaged.
- Memory chip is weakly soldered.
- Memory chip lead is short-circuited.

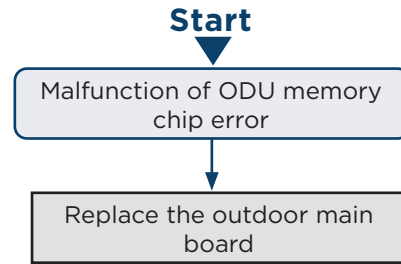

“H4” Overload

Error display:

ODU main board LED display

Error judgment condition and method:

When condensing pressure is higher than the protection value, system will report overload protection.

Possible causes:

- Cooling ODU heat exchanger is blocked or heat exchange is bad.
- Heating IDU heat exchanger is blocked or heat exchange is bad.
- Operating temperature is too high.
- System is over charged

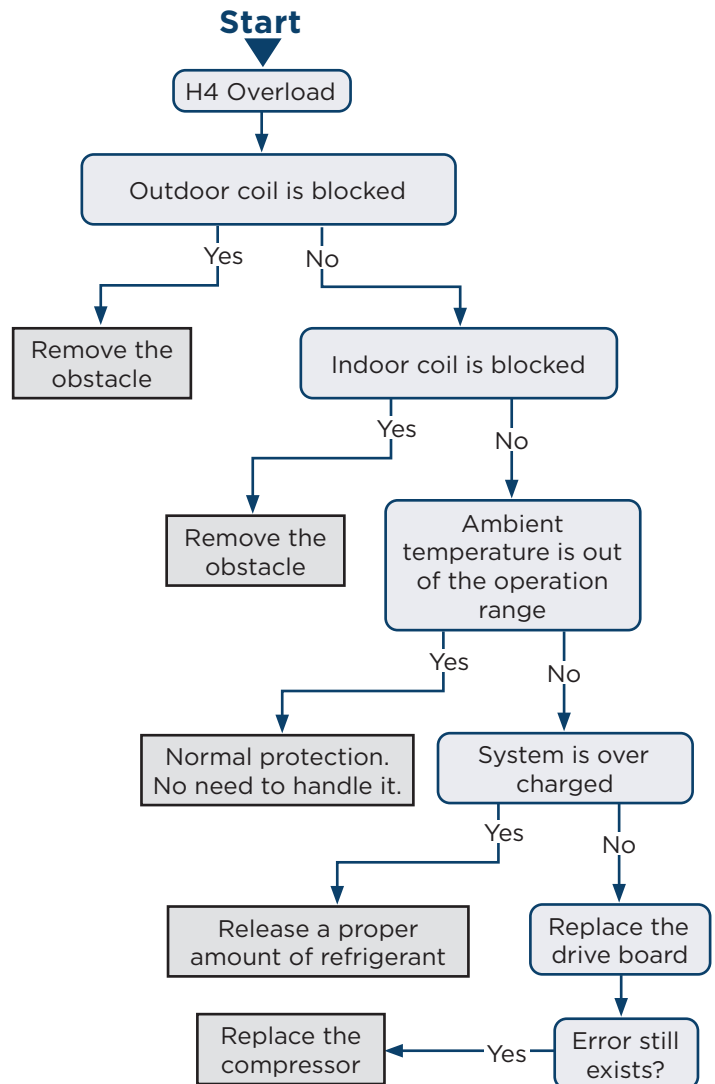

Troubleshooting

“H5” IPM Protection

Error display:

ODU main board LED display

Error judgment condition and method:

Drive processor supply voltage is low. IPM module malfunction. System will shut down.

Possible causes:

- Compressor 3-phase wire connection has open phase or is phase-reversed.
- System is overloaded and compressor current is too high.
- Drive board IPM module is damaged.
- Drive board IPM module’s 15V power supply is lower than 13.5V.
- Drive board 6-line PWM signal and the corresponding element are abnormal.
- Drive board compressor current sampling circuit element is damaged or drive chip current sampling AD terminal is abnormal.
- Compressor is damaged.

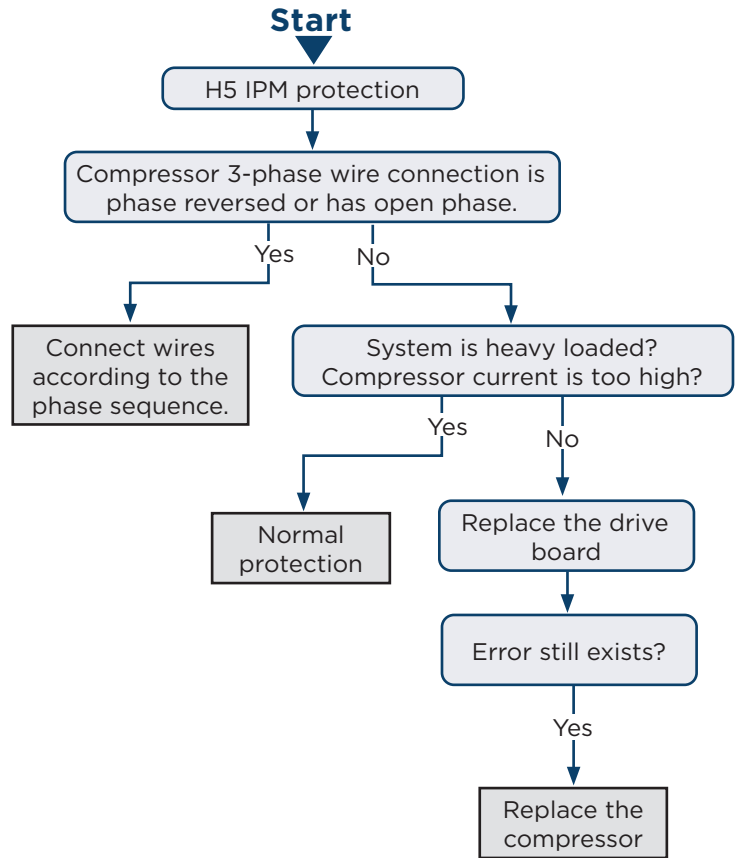

“H6” DC Fan Error

Error display:

ODU main board LED display

Error judgment condition and method:

Main board does not receive the outdoor fan signal within 30 seconds after outdoor fan run call is initiated

Possible causes:

- Outdoor fan wiring terminal is not correctly connected to the main board.
- Outdoor fan is damaged.
- Outdoor fan software is incorrect. This can occur after the outdoor fan has been replaced.

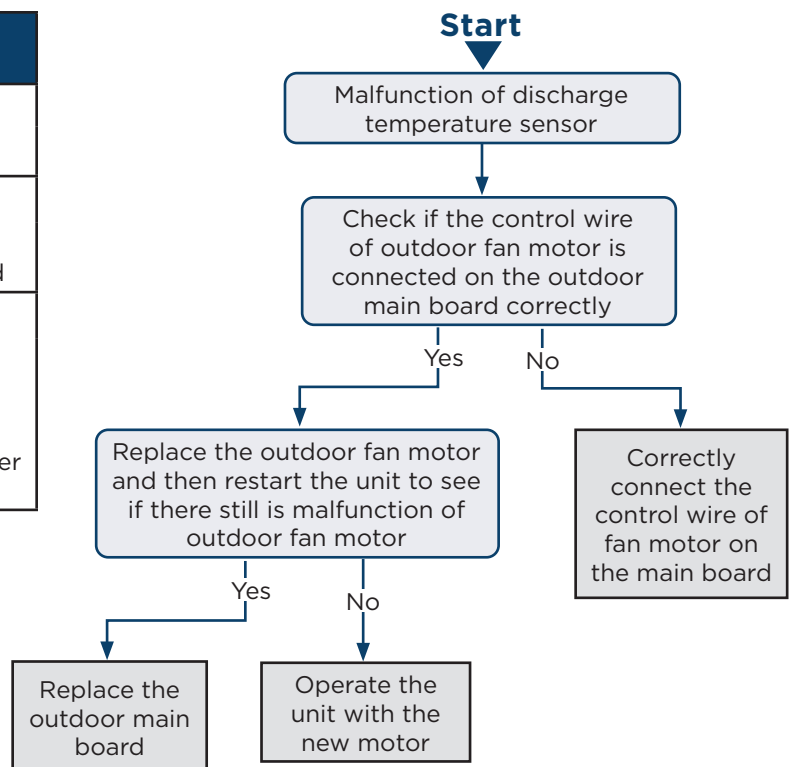

“H7” Driver Out-of-Step Protection

Error display:

ODU main board LED display

Error judgment condition and method:

The processor cannot detect the compressor rotor position. The running speed is different that the speed called for. Either case will stop compressor operation.

Possible causes:

- Compressor 3-phase wire connection is out of phase or phase-reversed.
- Compressor wiring is out of phase.
- System is blocked, short of refrigerant or compressor oil.
- Drive board IPM module is damaged.
- Drive board compressor current sampling circuit element is damaged or drive chip current sampling AD terminal is abnormal.
- Compressor is damaged.

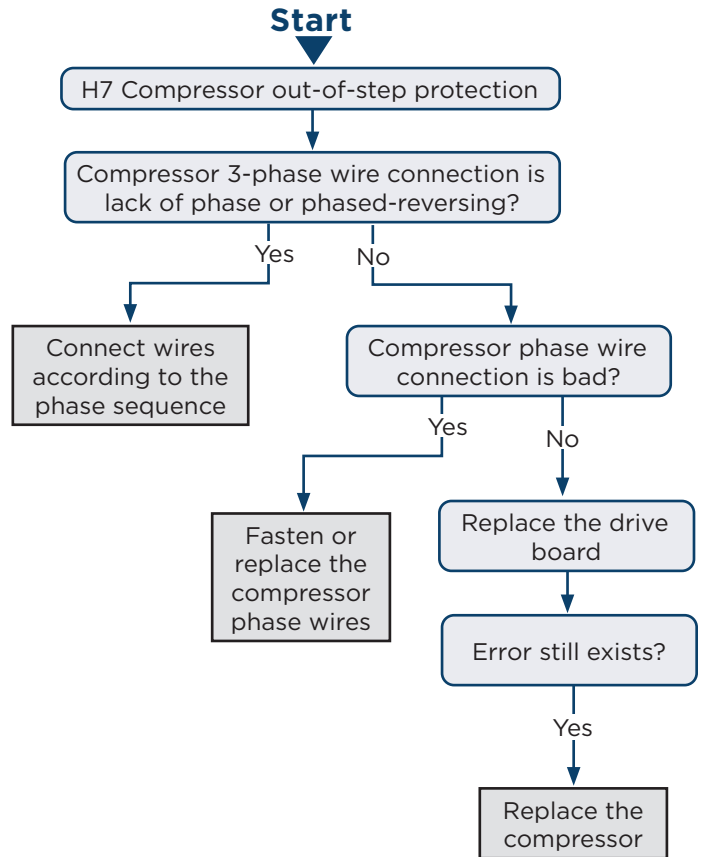

“HC” PFC Protection

Error display:

ODU main board LED display

Error judgment condition and method:

System shutdown due to drive processor low voltage malfunction.

Possible causes:

- Power grid voltage is abnormal.
- Drive board PFC module is damaged.
- Drive board IPM module’s 15V power supply is lower than 13.5V.
- Drive board PWM signal for PFC and the corresponding element are abnormal.
- Drive board PFC current sampling circuit element is damaged or drive chip current sampling AD terminal is abnormal.

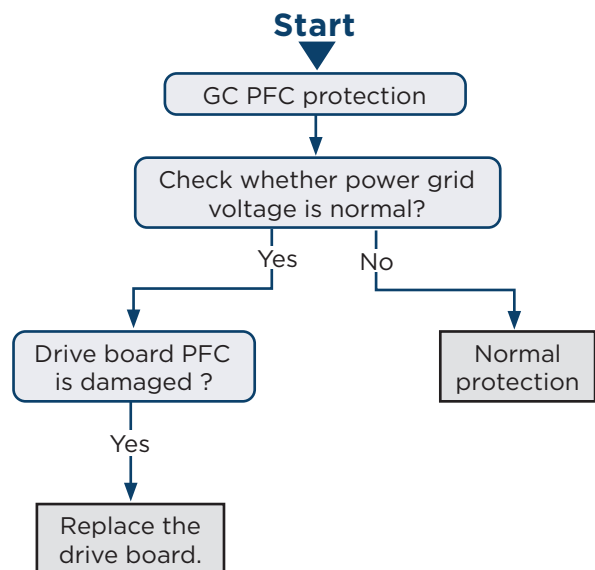

Troubleshooting

“Lc” Startup Failure
Error display: ODU main board LED display
Error judgment condition and method: Check the error code on 7 segment LED display of ODU main control board. Inverter compressor startup failure is indicated by a PJ on the display.
Possible causes: <ul style="list-style-type: none"> • Poor contact of compressor U, V, W wire • Compressor is faulty • Compressor drive board is faulty

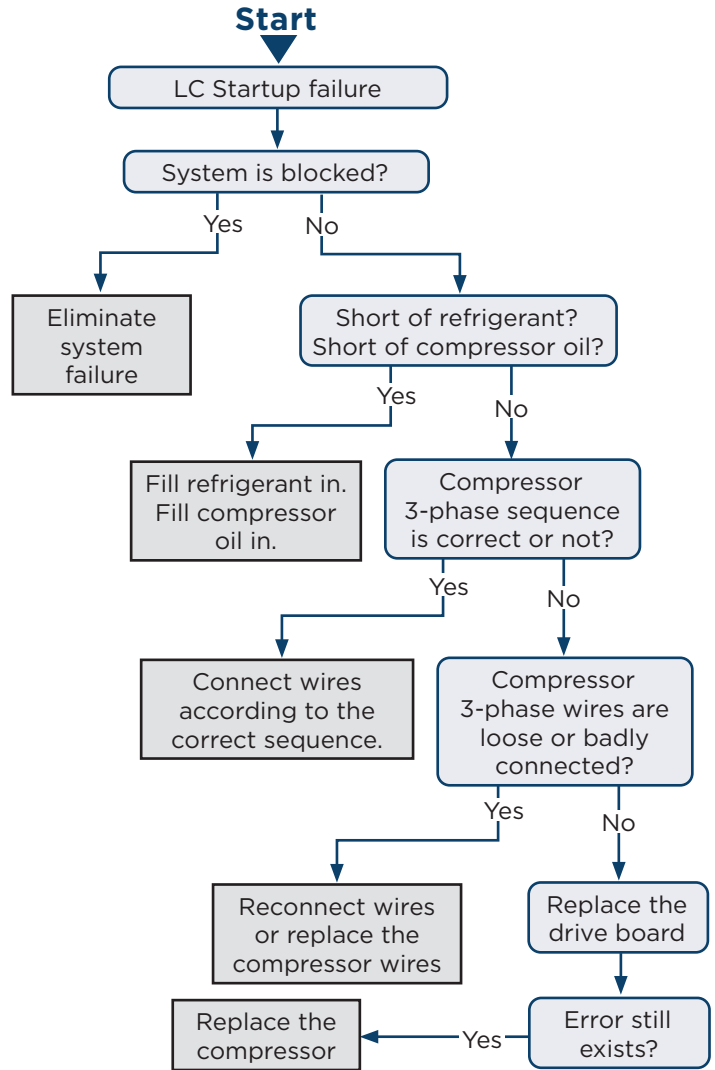

“P0” Driver Reset Protection
Error display: ODU main board LED display
Error judgment condition and method: Drive board chip resets and starts initialization. After the drive board is energized for 5s, it detects that the chip resets again. In this case, it can be judged as drive chip reset protection.
Possible causes: <ul style="list-style-type: none"> • 3.3V drive chip supply voltage drop. • TRST lead of JTAG programming is interrupted.

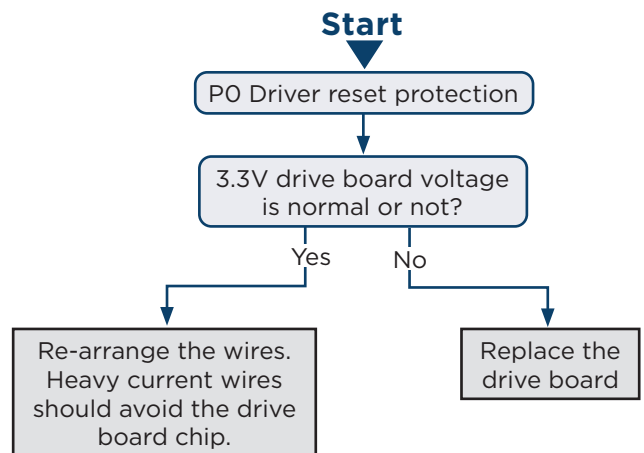

“P5” Over-Current Protection

Error display:

ODU main board LED display

Error judgment condition and method:

If compressor's instant current value is higher than the set current protection value, it will be judged that compressor over-current occurs and system will shut down for protection.

Possible causes:

- System load is too much and compressor current is too large.
- Compressor 3-phase wire connection is out of phase.
- Compressor wire is loose or has bad contact.
- Drive board current sampling circuit element is damaged or drive chip current sampling AD terminal is abnormal.
- Compressor is damaged.

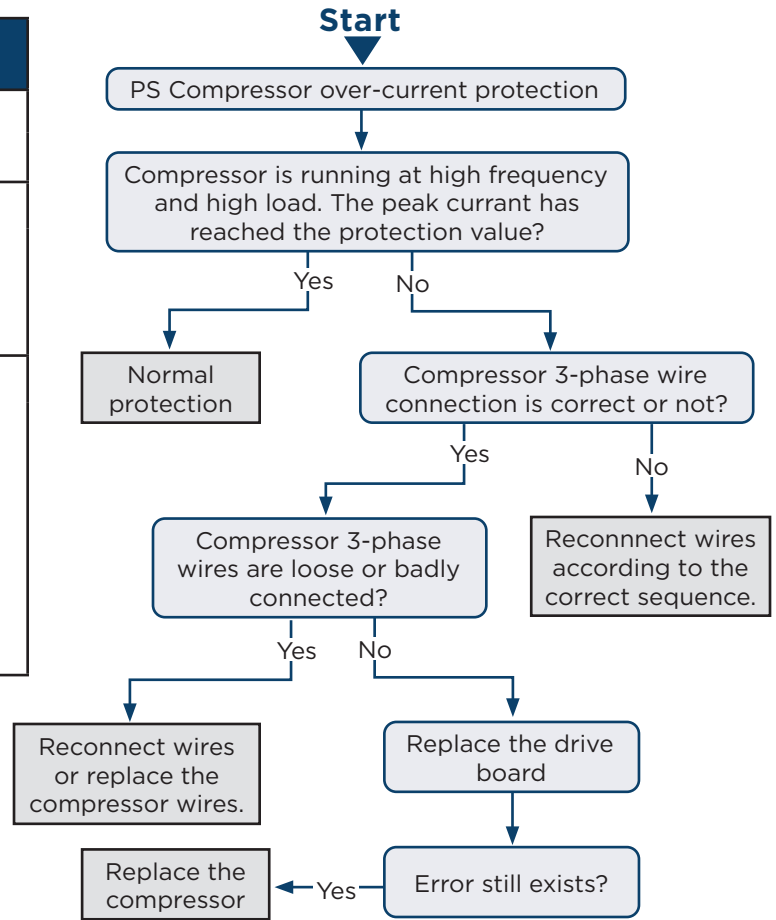

“P6” Master Control and Driver Communication Error

Error display:

ODU main board LED display

Error judgment condition and method:

If there is no other malfunction and the communication between master control and driver is cut off for 30s, then it can be judged that the communication between master control and driver is faulted. System will shut down for protection.

Possible causes:

- Communication wire between master control and driver is not well connected, or has bad contact, or is broken.
- The switch power of drive board is abnormal, therefore, the 3.3V power voltage is abnormal.
- Communication circuit of the drive board or the master control board is abnormal.

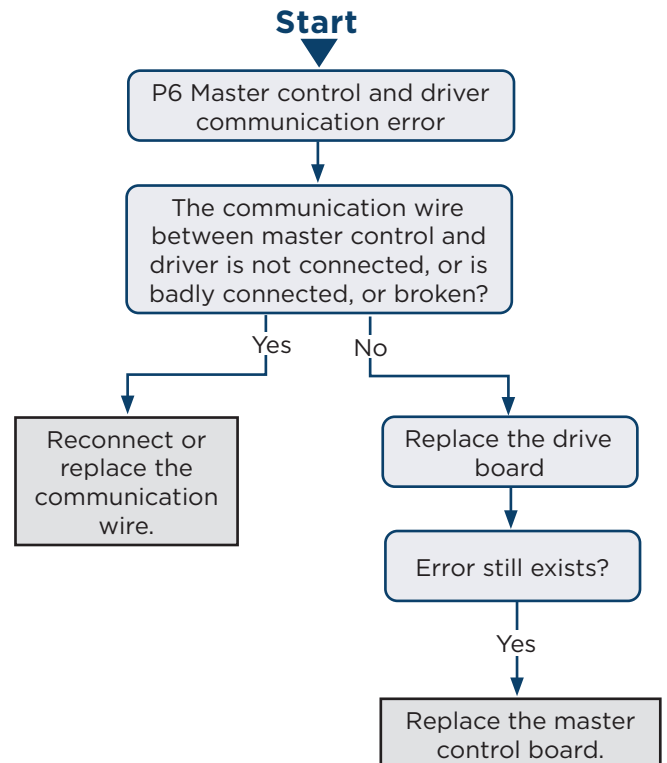

Troubleshooting

“P7” Driver Module Sensor Error

Error display:

ODU main board LED display

Error judgment condition and method:

If IPM or PFC module temperature is lower than the set protection value, then it can be judged that driver module sensor error occurs and system will shut down for protection.

Possible causes:

- Module temperature sensor is short-circuited or open.
- Drive board current sampling circuit element is damaged or drive chip current sampling AD terminal is abnormal.

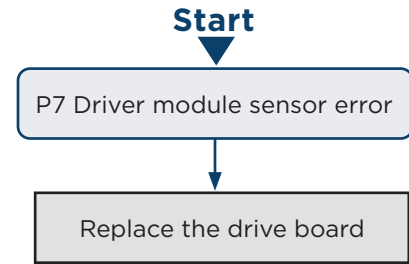

“P8” Driver Module High Temperature Protection

Error display:

ODU main board LED display

Error judgment condition and method:

If IPM module temperature or PFC module temperature exceeds the set protection value, then it can be judged that driver module temperature is too high and system will shut down for protection.

Possible causes:

- Thermal grease is not applied or not evenly applied to the module, or there is other substance on the back of the module.
- The module securing screws are not tight.
- Drive board temperature sampling circuit element is damaged or drive chip temperature sampling AD terminal is abnormal.

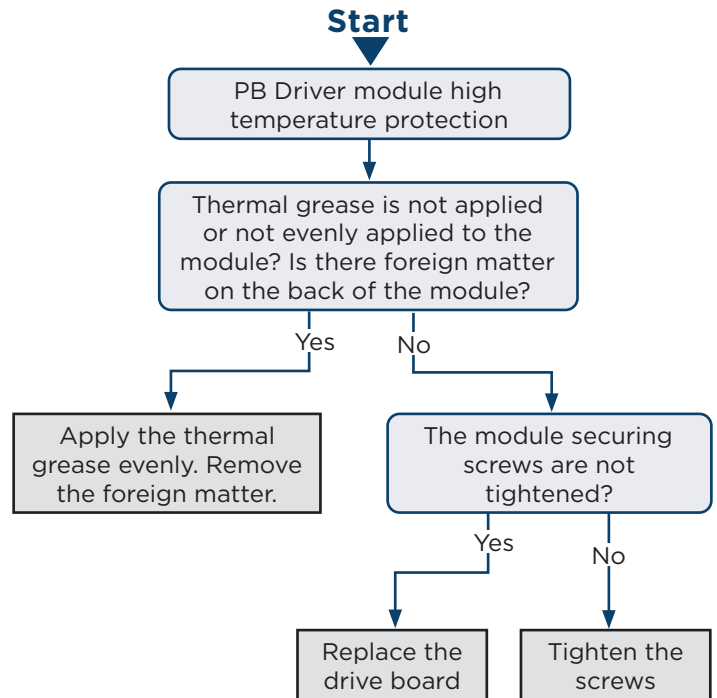

“PA” AC Current Protection

Error display:

ODU main board LED display

Error judgment condition and method:

If input current value exceeds the set protection value, then it can be judged that AC current protection occurs and system will shut down for protection.

Possible causes:

- System is heavy-loaded and compressor current is too large.
- Grid voltage is abnormal.
- PFC module is damaged.
- Drive board PFC current sampling circuit element is damaged or drive chip PFC current sampling AD terminal is abnormal.

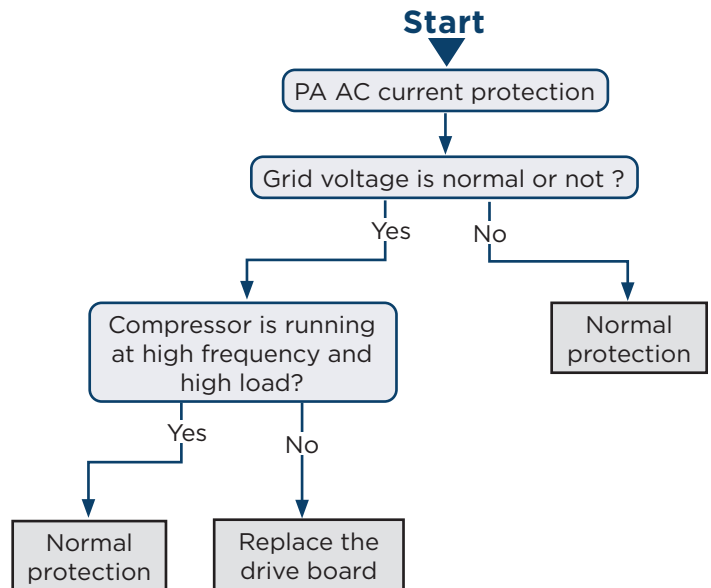

“Pc” Driver Current Error

Error display:

ODU main board LED display

Error judgment condition and method:

After power charging, if offset voltage average is detected to exceed 12.5% of 1.65V in 1s, then it can be judged that current detection (or current sensor) circuit is faulted. System will shut down for protection.

Possible causes:

- Current detection (or current sensor) sampling circuit element is abnormal.
- Drive chip compressor current sampling AD terminal is badly welded or short-circuited.

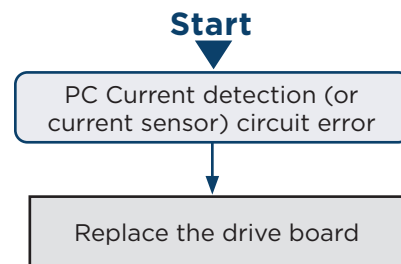

“PL” Bus Low-Voltage Protection

Error display:

ODU main board LED display

Error judgment condition and method:

When compressor is running and there is no other malfunction, if busbar voltage is lower than the set value for low voltage protection, then it can be judged that bus low-voltage protection occurs. System will shut down for protection.

Possible causes:

- Voltage of power grid is abnormal.
- Drive board busbar voltage sampling circuit element is damaged or drive board busbar voltage sampling AD terminal is abnormal.

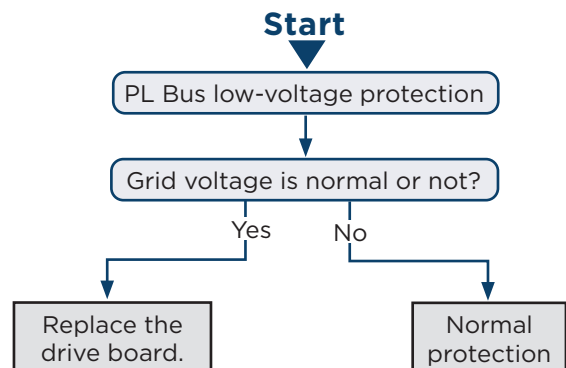

Troubleshooting

“PH” Bus High-Voltage Protection

Error display:

ODU main board LED display

Error judgment condition and method:

If there is no other malfunction and the busbar voltage is higher than the set value for high voltage protection, then it can be judged that bus high-voltage protection occurs. System will shut down for protection.

Possible causes:

- Voltage of power grid is abnormal.
- Drive board busbar voltage sampling circuit element is damaged or drive board busbar voltage sampling AD terminal is abnormal.

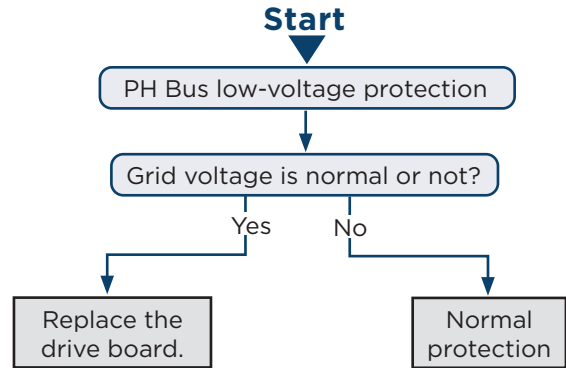

“PU” Charge Loop Error

Error display:

ODU main board LED display

Error judgment condition and method:

When the charge loop begins to charge and the busbar voltage cannot reach the set value in a certain period of time, it can be judged that charge loop error exists. System will shut down for protection.

Possible causes:

- Voltage of power grid is abnormal. Voltage is too low.
- Drive board charge loop element is abnormal.
- Drive board busbar voltage sampling circuit element is damaged or drive chip busbar voltage sampling AD terminal is abnormal.

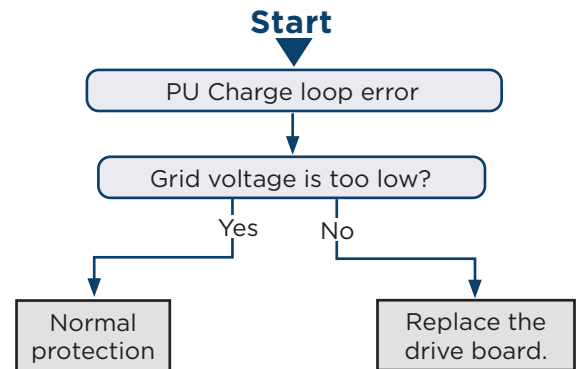

“ee” Drive Memory Chip Error

Error display:

ODU main board LED display

Error judgment condition and method:

If power is connected but the drive board and the memory chip cannot detect the memory chip or read the memory chip data correctly, then it can be judged that drive memory chip error exists.

Possible causes:

- The drive board that needs memory chip is not installed with the memory chip.
- The lead or connector of memory chip is badly welded or short-circuited.

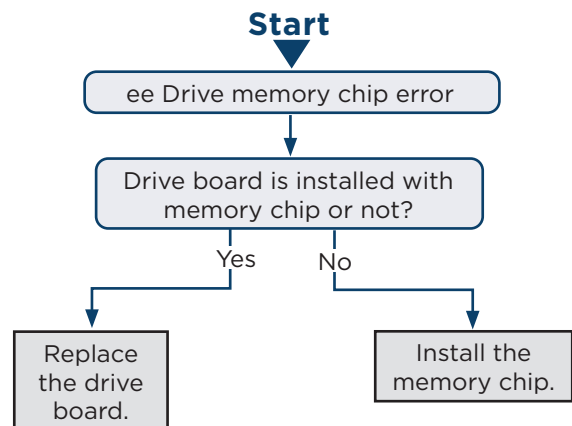

“e1” High Pressure Sensor Error

Error display:

ODU main board LED display

Error judgment condition and method:

Sample the AD value of pressure sensor through pressure sensor detecting circuit and judge the range of AD value, If the sampling AD value exceeds upper limit and lower limit in 30 seconds continuously, report the error.

Possible causes:

- Poor contact between pressure sensor and terminal in main board interface
- Pressure sensor is abnormal
- Detecting circuit is abnormal

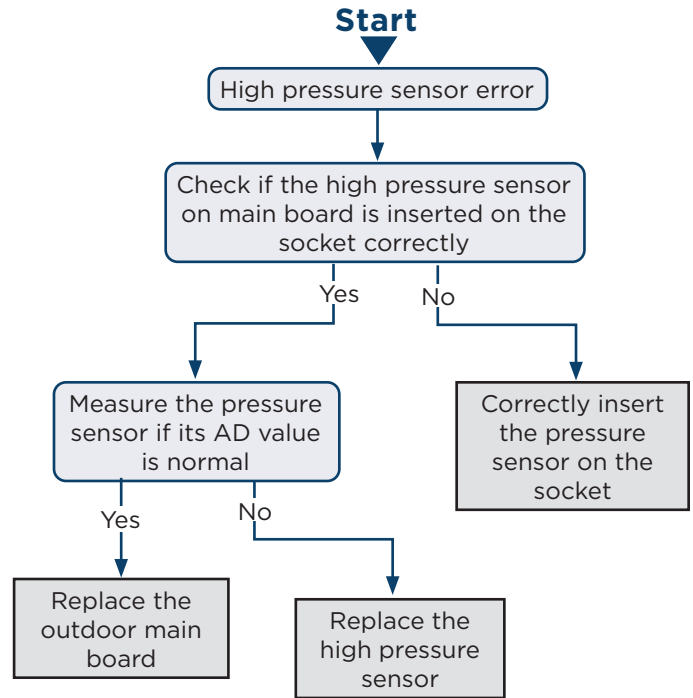

“C4” ODU Jumper Cap Error

Error display:

ODU main board LED display

Error judgment condition and method:

If jumper cap model doesn't match with main board, report the error

Possible causes:

- Jumper cap is not installed
- Jumper cap model is wrong
- Detecting circuit is abnormal

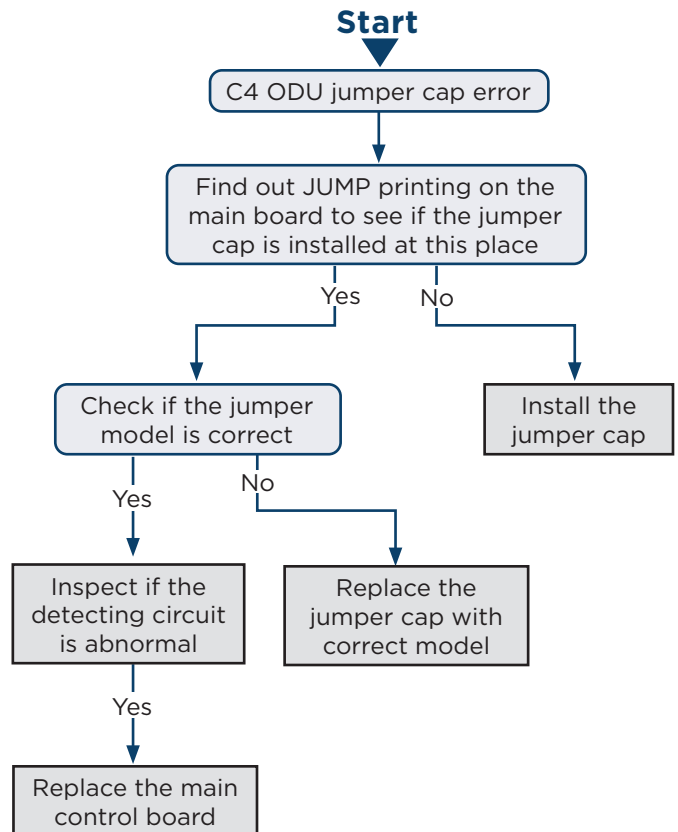

Troubleshooting

Failures Not Caused by Errors

If your heat pump fails to function normally, please first check the following items before contacting service:

Problem	Cause	Corrective measure
The heat pump doesn't run	The compressor is protected by a 3 minute time-delay.	Please wait for time delay protection.
	Wire connection is wrong.	Connect wires according to the wiring diagram.
	Fuse or circuit breaker is broken	Replace the fuse or switch on the circuit breaker.
	Power failure.	Restart after power is resumed.
	Power plug is loose.	Re-insert the power plug.
	Thermostat has weak battery.	Replace the batteries.
Bad cooling or heating effect.	Air inlet and outlet of the units have been blocked.	Clear the obstacles and keep the room for the units well ventilated.
	Improper temperature setting	Select a proper temperature.
	Fan speed is too low.	Select a proper fan speed.
	Air flow direction is not right.	Change the direction of air louvers.
	Doors or windows are open.	Close them.
	Exposed under direct sunshine.	Draw curtains or louvers in front of the windows.
	Too many heat sources in the room.	Remove unnecessary heat sources.
	Filter is blocked or dirty.	Send for a professional to clean the filter.
Air inlets or outlets of the units are blocked.	Clear away obstacles that are blocking the air inlets and outlets of the units.	

The following situations are not operation failures:

Problem	Time of occurrence	Cause
Mist comes from the heat pump.	During operation.	If the unit is running under high humidity conditions, the air in the room will condense.
The heat pump generates excessive noise.	System switches to heating mode after defrosting.	Defrosting process will generate some water, which will turn to water vapor.
	The heat pump is buzzing at the beginning of operation.	Thermostat will be buzzing when it starts working. The noise will become weak 1 min later.
Dust comes from the heat pump.	When the unit is turned on, it purrs.	When the system is just started, the refrigerant is not stable. About 30s later, the purr of the unit will dissipate.
	About 20s after the unit first enables the heating mode or there is refrigerant brushing sound when defrosting under heating.	It's the sound of 4-way valve switching direction. The sound will disappear after the valve changes its direction.
	There is hissing sound when the unit is started or stopped and a slight hissing sound during and after operation.	It's the sound of gaseous refrigerant that stops flowing and the sound of drainage system.
	There is a sound of crunching during and after operation.	Because of temperature change, front panel and other components may be expanding and contracting.
	There is a hissing sound when the unit is turned on or suddenly stopped during operation or after defrosting.	Because refrigerant suddenly stops flowing or changes the flow direction.
	The unit starts operation after being unused for a long time.	Dust inside the units come out together with the air.
The heat pump generates some smell.	During operation.	The room smell or the smell of cigarette comes out through the units



NOTICE:

- Check the above items and adopt the corresponding corrective measures. If the heat pump continues to function poorly, please stop the heat pump immediately and contact a local service contractor.

System Diagram

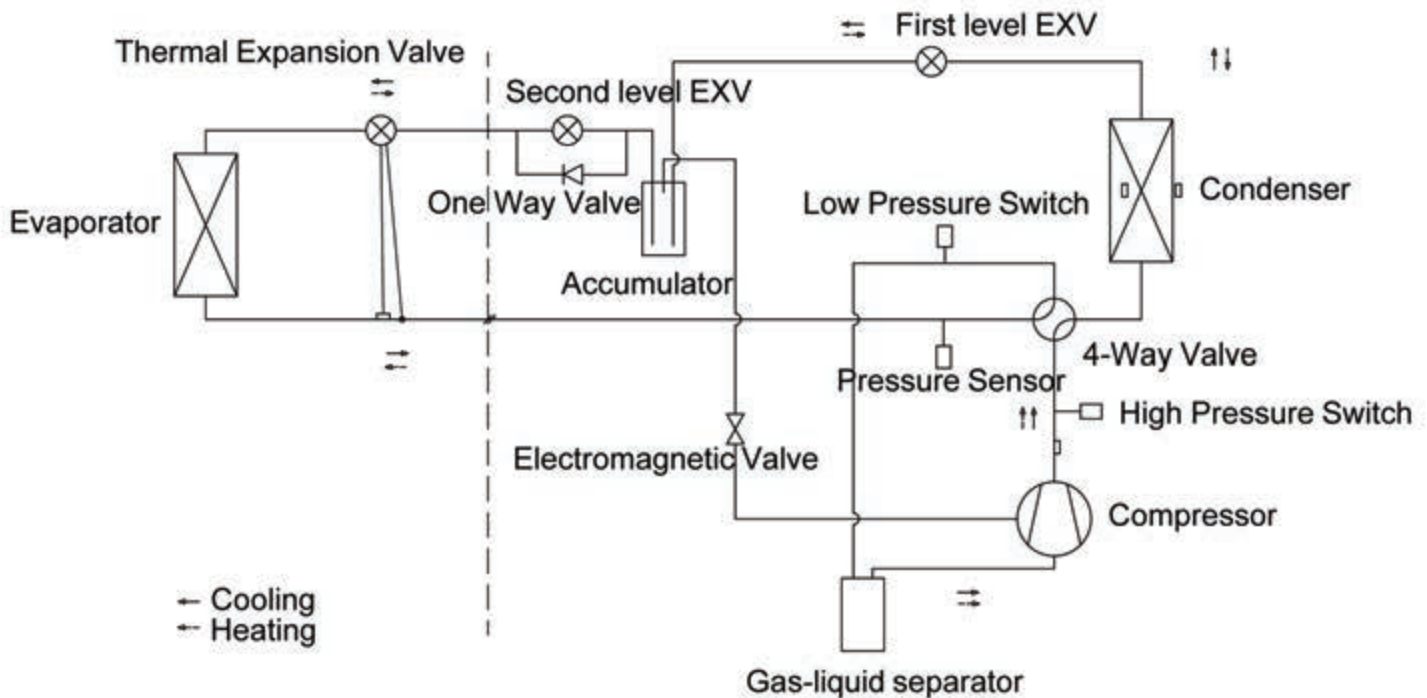

System Evacuation

NOTICE:

- Make sure the outlet of vacuum pump is away from fire source and is well-ventilated.
- Before evacuating, make sure the unit cut-off valves are closed.
- When evacuating, both the liquid pipe and the gas pipe must be evacuated.

1. Remove the outdoor unit caps of the liquid valve, gas valve and also the service port.
2. Meanwhile the gas and liquid valves should be kept closed in case of refrigerant leak.
3. Connect the hose used for evacuation to the vacuum pump.
4. Open the switch at the lower pressure side of the manifold valve assembly and start the vacuum pump. Meanwhile, the valve at the high pressure side of the manifold valve assembly should be kept closed, otherwise evacuation would fail.
5. The evacuation duration depends on the unit's capacity, generally:

Model	Time(min)
AUH2436ZGDA	35
AUH4860ZGDA	40

Verify if the pressure gauge at the low pressure side of the manifold valve assembly reads 350 microns, if not, it indicates there is leak somewhere. Then, close the valves fully and then stop the vacuum pump.

6. Wait for 10min to see if the system pressure can remain unchanged. If the pressure increase, there may be leakage.

Maintenance

- Slightly open the liquid valve and let some refrigerant go to the connection pipe to balance the pressure inside and outside of the connection pipe, so that air will not come into the connection pipe when removing the hose. Notice that the gas and liquid valve can be opened fully only after the manifold valve assembly is removed.
- Replace back the caps of the liquid valve, gas valve and also the service ports.

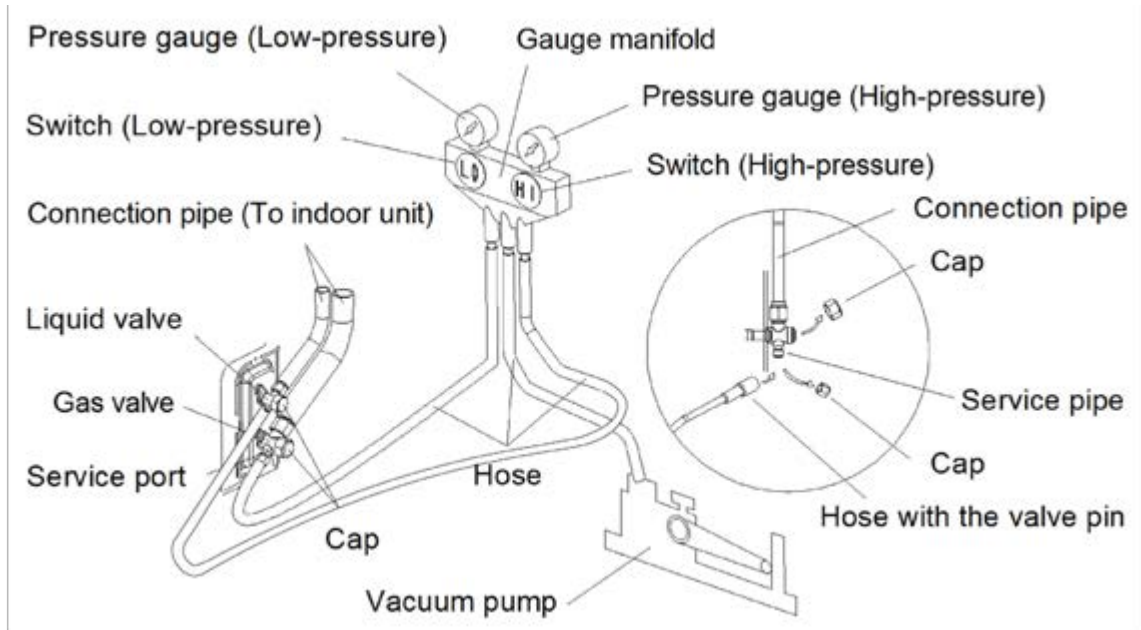

NOTICE:

- For large-size units, there are maintenance ports for liquid valve and gas valve. During evacuation, you may connect the two hoses of the manifold gauges to the maintenance ports to speed up the evacuation.
- Refrigerant should be reclaimed into the appropriate storage tank. System should use oxygen-free nitrogen purging to ensure safety. This process may need to repeat several times. Do not use compressed air or oxygen in this process.

Refrigerant Charging

Pre-Charging

- Connect the high pressure gauge line to the liquid service valve and connect the low pressure gauge line to the vapor line valve. Connect the middle gauge line to the vacuum pump. Power on the vacuum pump and evacuate the system.
- After evacuation, close the high and low pressure gauge valves and remove the middle gauge line from the connector of vacuum pump and connect the refrigerant tank.
- Loosen the middle gauge line from the connector and slightly open the refrigerant tank valve. Purge the middle gauge line. Tighten up the connector again and completely open the valve of refrigerant tank at the same time.
- Keep the refrigerant tank erect and put it on an electronic scale. Zero the scale.

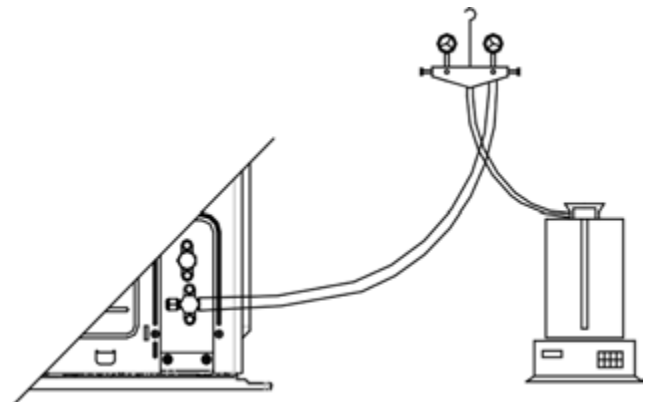

Maintenance

5. Open the high pressure gauge valve (Keep the low pressure gauge valve closed). Then charge refrigerant into the system.
6. Add the required amount of refrigerant calculated and close off the manifold gauge when complete.
7. If you can't continue to charge refrigerant into the system and the quantity of charged refrigerant is less than the required charging quantity, then restart the system and add the remainder of the required refrigerant into the vapor line while the system is running.
8. After charging, remove the pressure gauge.

Refrigerant Charging When Unit is Running

1. Connect the low pressure gauge line to the vapor line service valve and connect the high pressure gauge line to the service valve. Connect the middle gauge line to the vacuum pump. Power on the vacuum pump and evacuate the system.
2. After evacuation, close the high and low pressure gauge valves. Then remove the middle gauge line from the connector of vacuum pump and connect the refrigerant tank.
3. Purge the center hose.
4. Turn on the heat pump and let it run for a while.
5. Open the low pressure gauge valve (Keep the high pressure gauge valve closed) and charge add the remaining required refrigerant.
6. After all required refrigerant is charged in, close the valve of refrigerant tank.
7. Remove the pressure gauge to finish the refrigerant charging work.

Procedure of Refrigerant Charging

Following is the supplementary requirement for refrigerant charging on the basis of normal procedure:

1. Make sure that when charging refrigerant into the system, no other types of refrigerant will be mixed. The pipeline for refrigerant charging should be as short as possible to reduce the amount of refrigerant left in it.
2. The refrigerant tank should stand erect.
3. Make sure the refrigerating system is already grounded before refrigerant charging.
4. When charging is completed (or not yet completed), stick a label on the system.
5. Perform a final refrigerant leak test before leaving the work site.

Maintenance of Major Components

Replacement of Thermostat

Please refer to the instruction manual for your thermostat.

How to Replace the Compressor

Diagnosis of Compressor Failure: On Condition that the Unit CAN be Started Up

1. Start the unit if it will run and check the current of the faulted compressor. Use manifold gauges to measure the discharge and suction pressures at the service valves. Refer to the following table based on the recommended working current. The electric current of an inverter compressor will be different under different rotation speed or different working conditions. If the compressor is working at 60Hz, the working current corresponding to different condensing temperature and evaporating temperature is shown below:

Inverter compressor QXFT-F310zN450

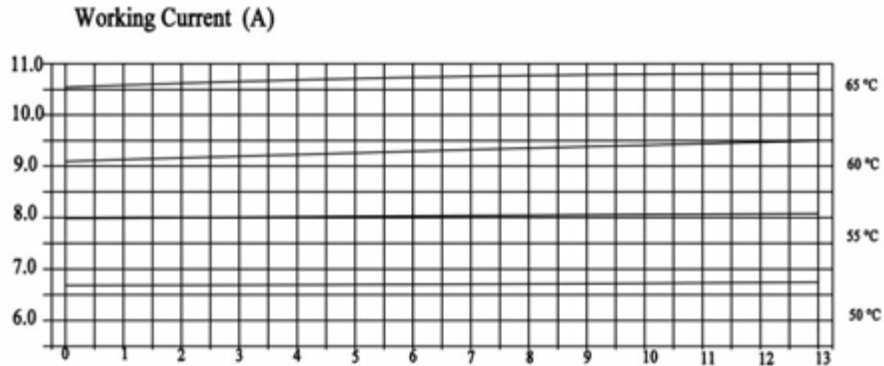

2. Judge whether the operating noise of the compressor is normal, and whether there is a sharp noise or obvious scraping. If there is a normal compressor working nearby, compare their operating noises.
3. Examine whether the electronic expansion valve of the outdoor unit is active and whether the 4-way valve works or not. How to examine:

I. Electronic Expansion Valve:

The electronic expansion valve will be reset every time when the unit is powered on or off. Touch the valve and you can feel the movement of the valve spool. In the last stage of the reset process, you will hear the click of the valve and feel its vibration.

Touch the electronic expansion valve:

- a. Touch the top of the electronic expansion valve and you can feel its move as it is reset upon startup.
- b. Make sure the coil is fixed firmly.

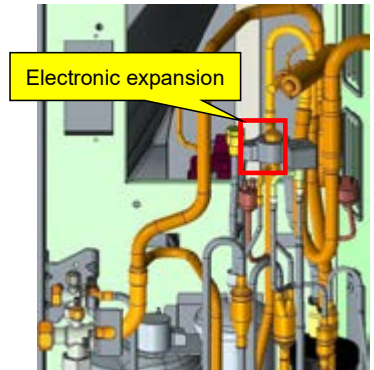

II. 4-way Valve:

During normal operation, the 4 copper tubes that connect to the valve will have different temperatures. When the 4-way valve is working, it will generate some noise and vibration.

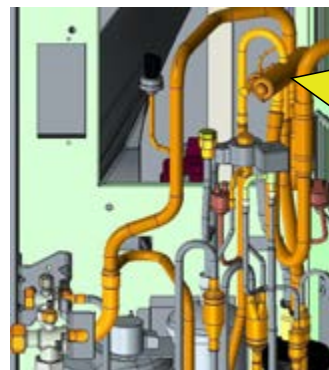

Labels on the 4-way valve:

D-connect to the discharge side; E-connect to the evaporator of indoor unit; S-connect to the suction side of the liquid separator; C-connect to the outdoor coil.

When the system is in cooling mode, C-the pipeline is with high pressure and high temperature; E, S-the pipeline is with low pressure and low temperature.

When the system is in heating mode, E-the pipeline is with high pressure and high temperature; C, S-the pipeline is with low pressure and low temperature;

Because D is connected to the discharge side, it is with high pressure and high temperature regardless of the operating mode. When the unit is powered on, in defrosting or oil return mode, the 4-way valve will produce some noise. Do not touch the pipes directly with your hands and be aware of the hot temperature.

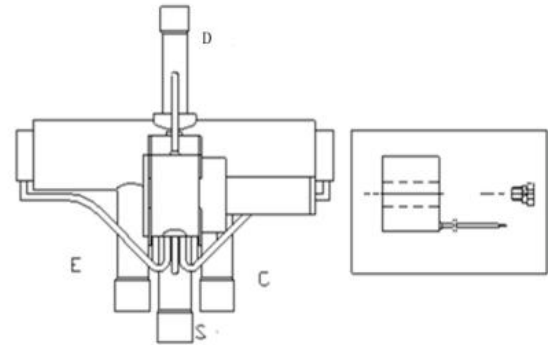

D- Connect to the exhaust side

Caution! High temperature!

4. Check the drive board of compressor, i.e. the IPM module. Please refer to the IPM checking method in the section of troubleshooting. Check the drive board of compressor, i.e. the IPM module. Please refer to the IPM checking method in the section of troubleshooting.

Diagnosis of Compressor Failure: On Condition that the Unit CANNOT be Started Up

1. Cut off the power supply and detach the cover of the wiring box of the compressor. Check the wiring connections of the compressor.
2. Check the resistance between the wiring terminals (U, V, W) of compressor.

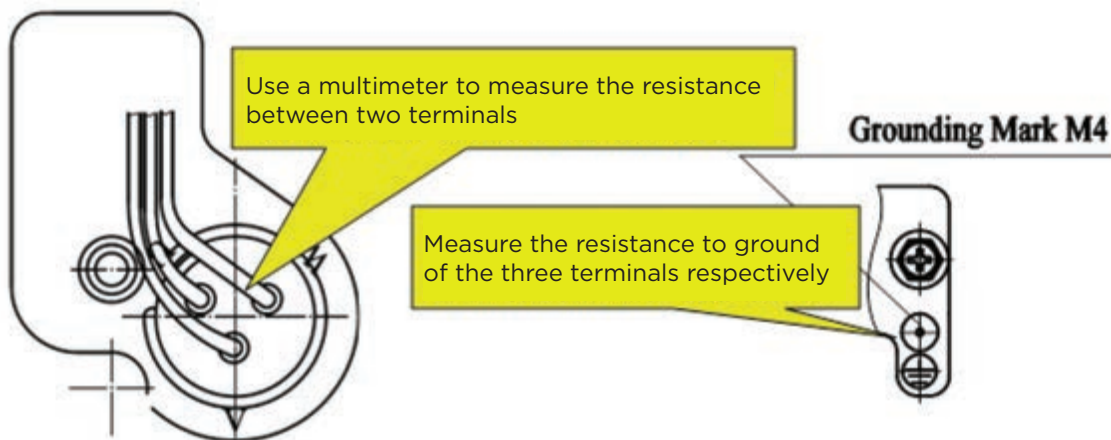

Refer to the following table for the resistance between any two terminals:

Compressor model	UV Winding Resistance	VW Winding Resistance	WU Winding Resistance
QXFT-F310zN450	0.79±7%Ω	0.79±7%Ω	0.79±7%Ω
QXAU-F516zX440A			

Measure the resistance to ground of each wiring terminal. The resistance should be above 10 megohm. If not, we can judge that the compressor windings are grounded.

3. On condition that the unit cannot be started up; we also need to check the solenoid valve assembly of the system including the electronic expansion valve. The checking method is the same as instructed above.
4. Check whether the IPM module is normal. Please refer to the IPM checking method in the section of troubleshooting.

Maintenance

Replacement of Compressor

1. Preparation

A. Prepare the components for replacement:

- Do not carry the compressors horizontally or upside down when carrying the compressors. Make sure the lubricant inside the compressor doesn't pour out from the oil refrigerant ports. The suction and discharge openings of the compressor must be sealed. Use tape for the openings if the rubber plugs are not available.

Make sure the rubber seals of the suction and discharge openings of the compressor are in good condition.

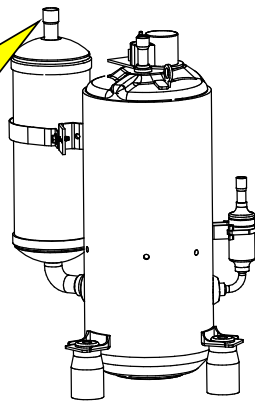

Make sure terminal box cover of the compressor is in good condition.

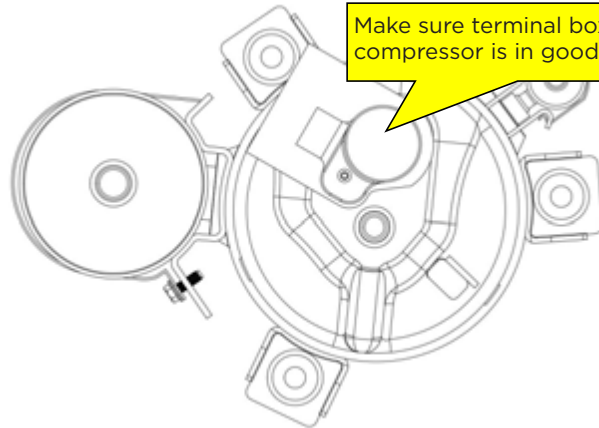

NOTICE:

- Before replacement, make sure the nameplates and models of the compressors are identical.
- Make sure the lubricant is sealed inside the compressors.

B. Prepare relevant tools:

- Prepare nitrogen. Please strictly follow the nitrogen welding standards during the welding process. Make sure there is sufficient nitrogen. The nitrogen pressure should be above 2" to 3" W.C.
- Prepare brazing rods. Common brazing rod contains less than 5% silver. This material is used for brazing copper to copper. The refrigerant ports of our compressor are made from copper-plated steel, so we must use 15% brazing rod.
- Prepare applicable welding tools. Please evaluate how much oxygen and acetylene should be used according to the current welding condition. Try to avoid repeated welding.
- Prepare a complete set of tools, including an internal hexagonal wrench, diagonal pliers, pincer pliers, nipper pliers, a multimeter, a pressure gauge, phillips screwdriver, straight screwdriver, more than two wrenches, insulating tape and wire ties.

2. Disconnect power

- If the compressor needs to be replaced after judging as above, then switch off the outdoor unit and disconnect the power cable of the outdoor unit. Use insulating tape to wrap the power cable and put a notice card on the power switch to remind people to be cautious of electric shock.

3. Preparation of electric components

- When you detach the compressor wires, temperature sensors and electric heaters, mark them correspondingly for the convenience of reconnecting them.

4. Recover refrigerant

- Recover refrigerant from the system. Recover simultaneously from the high pressure side and low pressure side. Do not recover too quickly; otherwise large quantity of lubricant will escape from the system together with the refrigerant.

5. Detach the compressor

- Check the condition of the damaged compressor, including its position and model.
- If the information of the compressor is confirmed, check the oil quality.
 - I. If the oil is clear and impurities-free, we consider that the oil of the system is not polluted. Meanwhile, if we confirm that the valves and pipes are also normal, then we can replace the compressor only. For the removal of compressor, please refer to the section: Removal of Major Components.
 - How to check oil quality:
 - A. After the compressor is detached, put it on a solid surface and shake it at an angle of 30-45° to ensure that the contaminant at the bottom of the compressor can be poured out.
 - B. Place the compressor at a position above the ground level and then pour out the oil from the suction inlet of the compressor. Collect the oil in a transparent container. The amount of oil should be over 150ml.
 - Notes:
 - The axial direction of the compressor should not slant at an angle larger than 20° to the horizontal plane.
 - Prevent the compressor from falling.
 - Put a transparent container (over 150ml in volume) under the suction port to collect the compressor oil, thus we can see the oil quality.
 - C. Put the container of compressor lubricant in a bright location and see if there is impurity and discoloration. Sniff at the compressor lubricant. Normally, there is no pungent smell.
 - II. If the oil is contaminated, replace the compressor and the gas-liquid separator.
 - Note: Confirm whether the compressor needs to be replaced. The refrigerant ports of the faulted compressor must be sealed by adhesive tape as soon as the compressor is detached. Make sure the compressor is well preserved for future analysis.

6. Check the components

- If the oil is contaminated, check the components of the unit, including the gas-liquid separator.
- Check the gas-liquid separator.
- When the separator is detached, check whether there are impurities inside. Testing method is listed below.
 - Note: When pouring the liquid from the separator, make sure the discharge pipe is at the lower position. Slant at an angle not greater than 20°
 - Use a transparent container to collect the content inside the separator. Check its color, seal it well and return it to the factory for inspection.
 - Note: If the compressor is damaged and needs to be replaced, the gas-liquid separator should also be replaced, whether or not there are impurities in the separator or other abnormal conditions.
 - Confirm which parts of the system should be replaced. Make sure the refrigerant ports of the damaged parts or components are sealed by adhesive tape as soon as they are detached. Keep them in the original condition for future analysis.

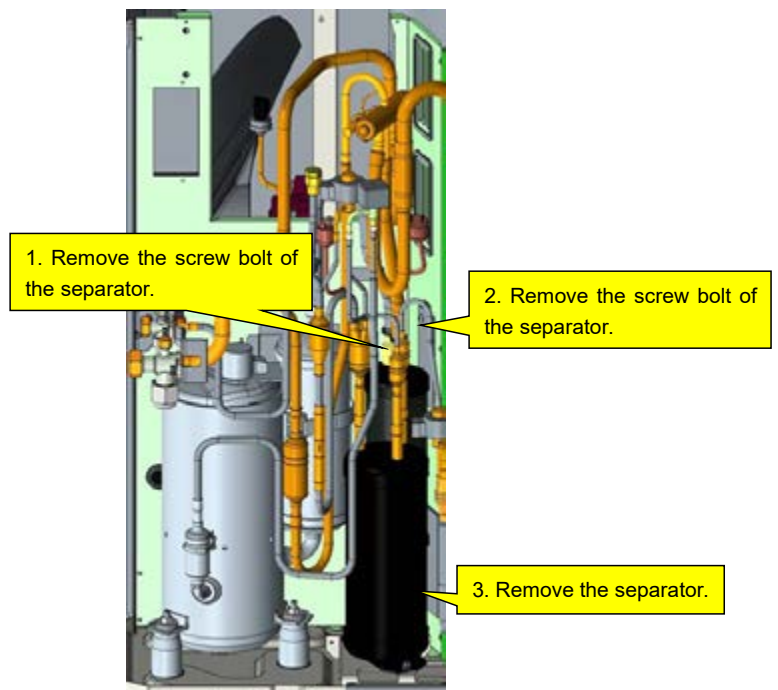

Maintenance

7. Clear the pipeline

- After confirming which parts of the system should be replaced, check the pipeline of the system. Blow through the main pipeline with nitrogen. After clearing the pipeline, if the components are not replaced immediately, seal the pipeline with adhesive tape to prevent the system from being contaminated by moisture and impurities in the air.

8. Replace the compressor

- For the removal of compressor, please refer to the section: Removal of Major Components.

9. Check/Replace the gas-liquid separator

- Note: If a compressor is damaged and needs to be replaced, its gas-liquid separator should also be replaced. This will avoid the abnormal condition of the separator from affecting the safe and reliable operation of the system.
- For the removal of gas-liquid separator, please refer to the section: Removal of Major Components.

10. Check the system for leaks

- First of all, check each brazing point. Check whether the brazed joints are smooth and whether there is any obvious flaws or other abnormal condition.
- Next, fill high-pressure nitrogen into the system for leak detection. If it is only the outdoor unit that needs to be repaired and the indoor unit is confirmed normal, then it's OK to charge high-pressure nitrogen into the outdoor unit only. Fill with nitrogen simultaneously from the high pressure side and low pressure side. We recommend charging the nitrogen from the both service valves at the same time. Nitrogen pressure should be greater than 150 psi. Use soapy water to check for leaks. Check the brazed joints particularly.
- Finally, pressurize the entire system. Fill high-pressure nitrogen into the system and maintain 300 psi. Close both service valves and maintain the pressure of indoor and outdoor units for more than 12h. If the pressure remains unchanged, then start system evacuation; otherwise, check the system for leaks again. Temperature should be considered when judging the pressure change. If temperature changes by 2°F, pressure will change by 1-1/2 psi or so.

11. Evacuate the system and charge refrigerant

- Please refer to the section of maintenance: vacuum pumping and refrigerant charging.

12. Connect electric components

- Connect cables, compressor wires and the electric heating belt according to the signs marked before and the wiring diagram on the cover of the electric box.

How to Replace the Compressor Drive Module

1. First, make sure that power is off. Use a multi meter to measure the voltage between L1, L2, L3, and N. to be sure the voltage is isolated. Tag the breaker to indicate that the equipment is under repair.
2. Measure the voltage between DC bus P and N on the drive board of the compressor. Set the multimeter for DC voltage and measure the voltage between P and N as shown below. If the voltage is below 36V, proceed with the next step.
3. Remove all the wires on the drive board of the compressor.

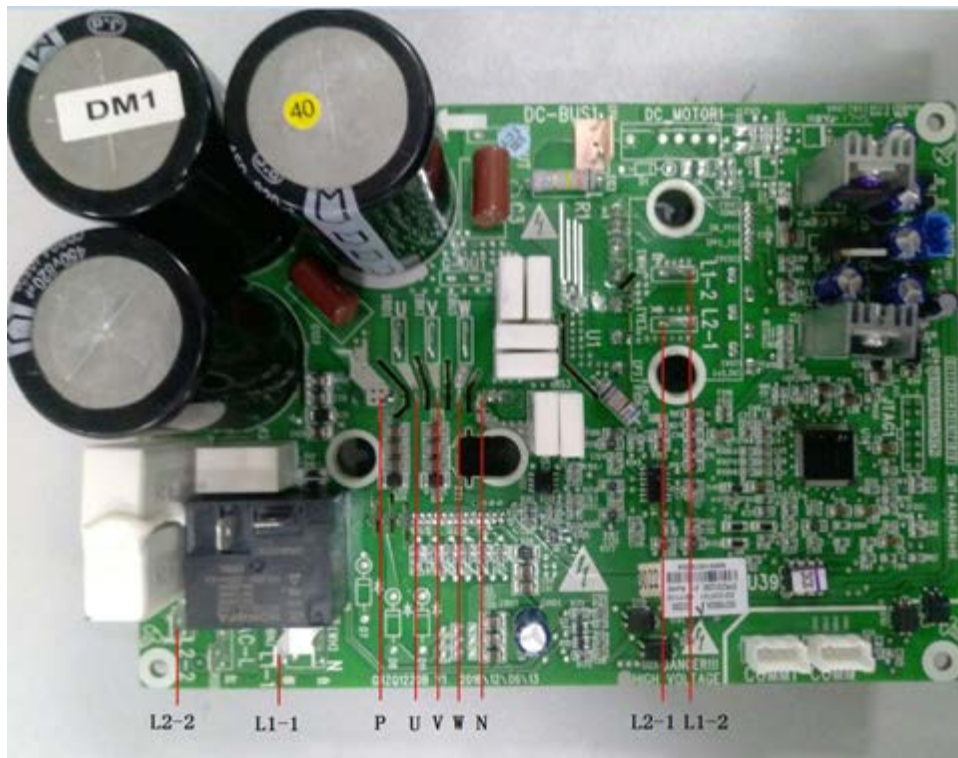





4. Remove the screws on the drive board of the compressor. The screws are located in the white circles as shown above in the picture.
5. Replace with a new compressor drive board. Before replacement, apply some silica gel on the IPM module.
6. Install the new compressor drive board. Tighten the screws and connect the wires correctly.

Maintenance

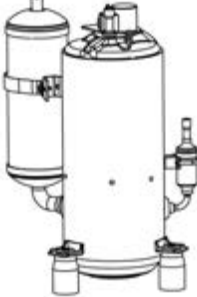
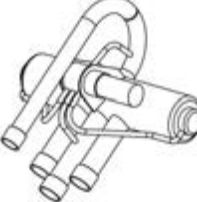
Removal of Major Components

Removal of ODU Major Components

Picture	Name	Function
	Compressor	Through compression, the low pressure refrigerant becomes pressurized. As its pressure and temperature both rise, it becomes high pressure and high temperature refrigerant. It is the power drive of the system.
	4-way valve	It is used to change the direction of refrigerant flow for heating and cooling.
	Motor	The power drive of the fan. It enables the fan to run so as to provide air to flow across the coil and transfer heat from the coil to the air.
	Fan	It is used to provide smooth currents of air for forced convection and heat exchange of condenser and evaporator.
	Gas liquid separator	Installed at the suction side of compressor, it can separate the liquefied refrigerant from the gaseous refrigerant to make sure that only gaseous refrigerant will be drawn into the compressor. Ineffective compression or slugging phenomenon will occur if liquid refrigerant enters the compressor.

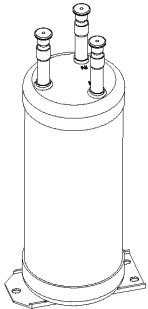
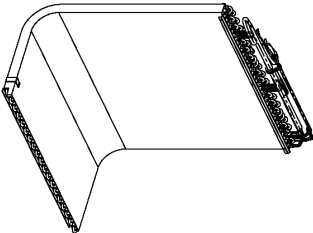
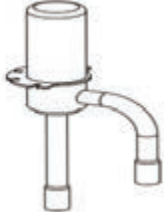
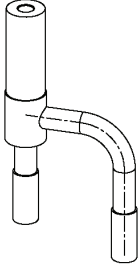
Picture	Name	Function
	<p>Accumulator</p>	<p>Flash refrigerant from liquid to gas</p>
	<p>Outdoor coil</p>	<p>It is used to transfer partial heat of the hot flow to the cold flow so that the flow temperature can reach the specified index. It is an energy exchanging device.</p>
	<p>Electronic expansion valve</p>	<p>It is used to lower the pressure and temperature of liquefied refrigerant and adjust the flow of refrigerant entering the coil.</p>
	<p>Solenoid Valve</p>	<p>Electromagnetic valve controls increased enthalpy switch.</p>

Maintenance

Model: AUH2436ZGDA

Front Panel Removal

Note: Be sure power is off before removing front panel.

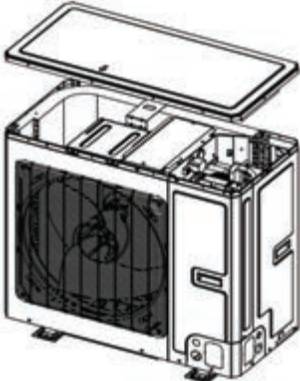
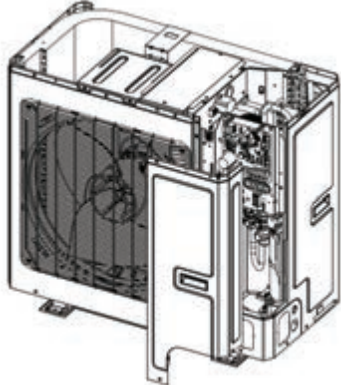
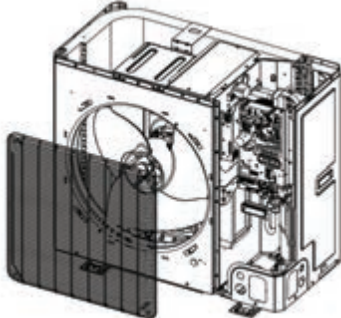
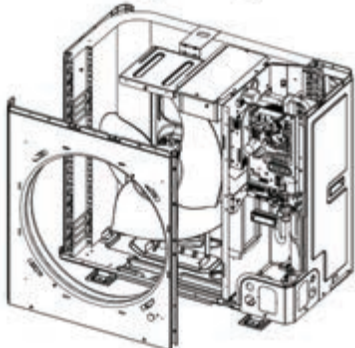
Step	Picture	Work instruction
1. Remove the upper cover plate.		Unscrew the screws of the upper cover plate with a screwdriver.
2. Remove the front side plate.		Unscrew the screws of the upper and front side plate with a screwdriver.
3. Remove the front grill.		Unscrew the screws of the front grill with a screwdriver.
4. Remove the front panel.		Unscrew the screws that connect the front panel to the middle insulating board and screws around the front panel.

Front Panel Removal

Note: Be sure power is off before removing front panel.

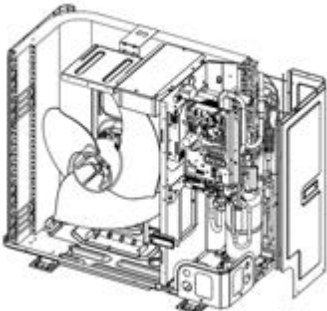
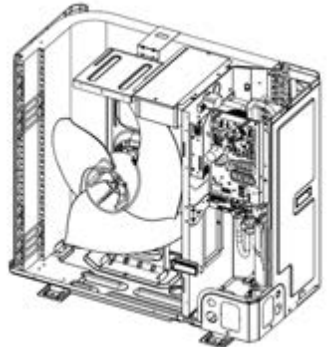
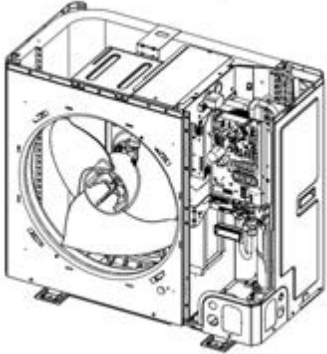
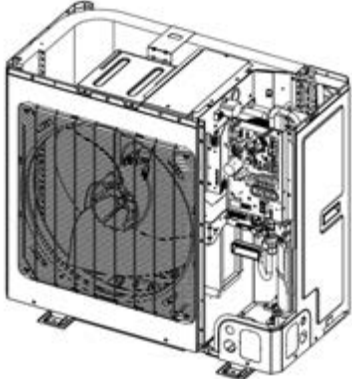
Step	Picture	Work instruction
5. Remove the right side plate.		<p>Unscrew the screws that connect the right side plate to the electric box and the screws around the right side plate.</p>
6. Install the right side plate		<p>Screw up the screws around the right side plate. Be careful to handle well the clasps at the bottom of the right side plate.</p>
7. Install the front panel.		<p>Install the front panel by mounting on 6 clasps on its both sides. Please note that there is one screw on the lower right side.</p>
8. Install the grill.		<p>Attach the grill back in place and tighten up the screws.</p>

Maintenance

Front Panel Removal

Note: Be sure power is off before removing front panel.

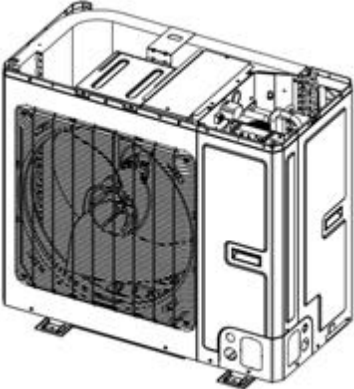
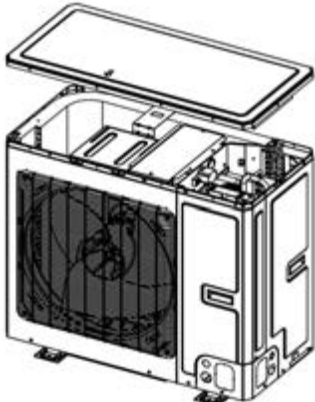
Step	Picture	Work instruction
9. Install the front side plate.	 A technical line drawing of a washing machine's front panel assembly. The front side plate is shown partially attached to the main front panel. The side plate has a mesh-like texture and is being secured to the main panel.	Fix the clasps on both sides of the plate and tighten up the screws.
10. Install the upper cover plate.	 A technical line drawing of a washing machine's front panel assembly. The upper cover plate is shown being placed onto the top of the front panel. The plate is rectangular and fits over the top edge of the main panel.	Tighten up the screws around the upper cover plate.

Model: AUH2436ZGDA

Compressor/Gas Liquid Separator Removal

Note: Make sure all refrigerant is recovered and power is isolated before removing compressor and gas liquid separator.

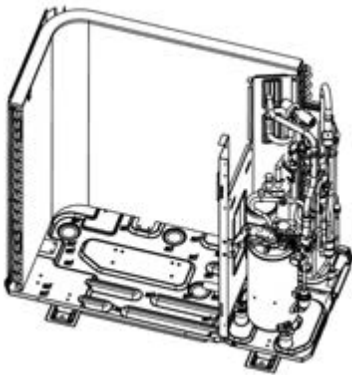
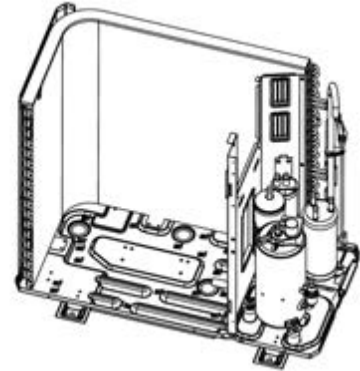
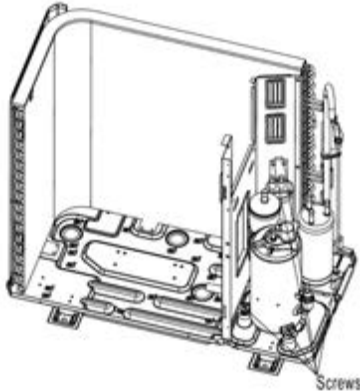
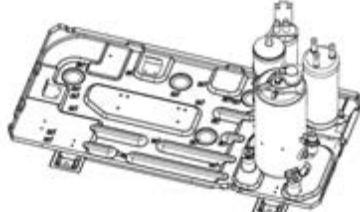
Step	Picture	Work instruction
<p>1. Remove wires.</p>		<p>Loosen the securing screws of the wires with a screwdriver.</p> <p>Remove the wires.</p> <p>Note: When removing the wires, mark the wire terminals corresponding to their color so as to avoid misconnection.</p>
<p>2. Break off the pipes that connecting to the compressor/gas liquid separator.</p>		<p>Braze the pipes that are connected to the compressor/gas liquid separator.</p> <p>Then remove the pipes. Note: When welding the pipes, do not let the flame burn the other components.</p>
<p>3. Loosen the compressor's base connectors / gas liquid separator's base nuts.</p>		<p>Use a wrench to twist off the compressor/gas liquid separator's base nuts.</p>
<p>4. Remove the compressor/gas liquid separator from the chassis.</p>		<p>Take away the compressor/gas liquid separator and replace with a new one.</p> <p>Note: When replacing the compressor/gas liquid separator, avoid touching the nearby pipeline and components.</p>

Compressor/Gas Liquid Separator Removal

Note: Make sure all refrigerant is recovered and power is isolated before removing compressor and gas liquid separator.

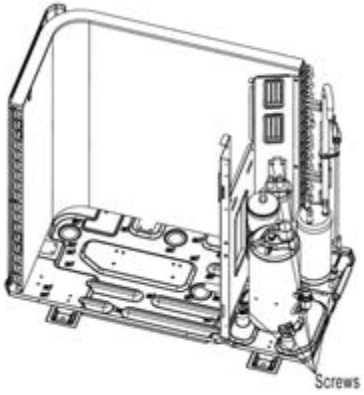
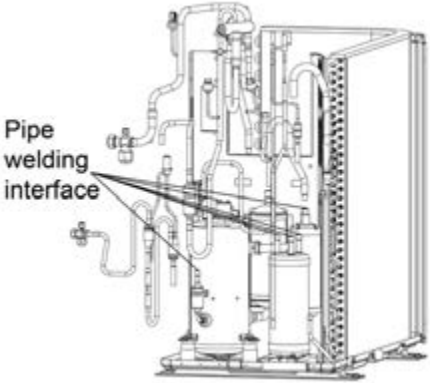
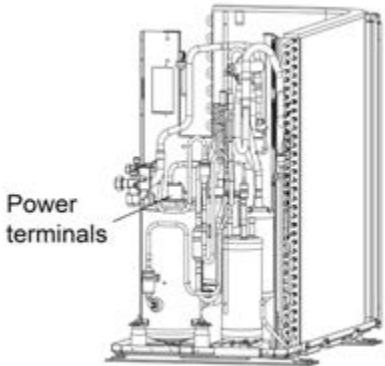
Step	Picture	Work instruction
<p>5. Install the new compressor/gas liquid separator onto the chassis.</p>		<p>After replacing the compressor/gas liquid separator, tighten up the base screw nuts.</p>
<p>6. Connect the brazing interfaces of compressor/gas liquid separator to the pipeline.</p>		<p>Braze the connection pipes of compressor to connect them to the compressor.</p> <p>Note: When replacing the compressor, avoid touching the nearby pipeline and components.</p>
<p>7. Connect the compressor wires.</p>		<p>Connect the compressor wires to the wire terminals on the top of compressor.</p> <p>Note: When connecting the wires, be sure to match the colors with the corresponding wire terminals.</p>

Maintenance

Model: AUH2436ZGDA

4-Way Valve Removal

Note: Make sure refrigerant is fully recovered and power is isolated before removing the 4-way valve.

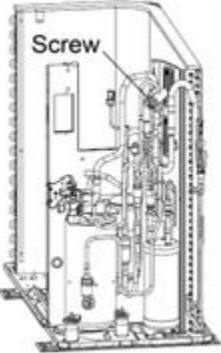
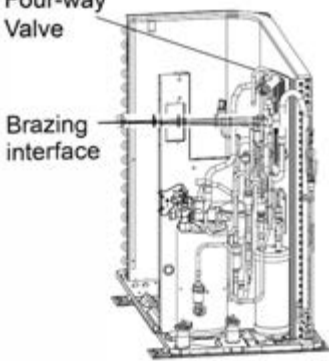
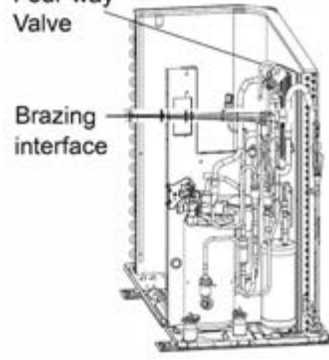
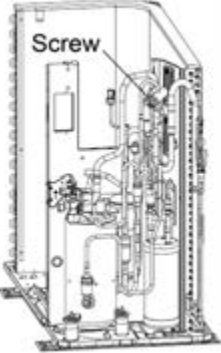
Step	Picture	Work instruction
<p>1. Remove the solenoid coil from the 4-way valve</p>	 <p>Screw</p>	<p>Carefully unscrew the screws of electromagnetic coil with a screwdriver.</p>
<p>2. Break off the connection pipes from the 4-way valve.</p>	 <p>Four-way Valve</p> <p>Brazing interface</p>	<p>Use a torch to loosen the 4 joints on the 4-way valve and then remove the connection pipes.</p> <p>Note: When brazing the pipes, the 4-way valve should be wrapped with wet cloth for cooling. Do not let the flame burn the other components.</p>
<p>3. Replace the 4-way valve and connect it to the connection pipes.</p>	 <p>Four-way Valve</p> <p>Brazing interface</p>	<p>Replace the 4-way valve and then use a torch to braze the 4 joints of the 4-way valve.</p> <p>Note: When brazing the pipes, the 4-way valve should be wrapped with wet cloth for cooling. Do not let the flame burn the other components.</p>
<p>4. Install the coil of 4-way valve.</p>	 <p>Screw</p>	<p>Tighten the screws of the coil of 4-way valve with a screwdriver.</p>

Maintenance

Model: AUH2436ZGDA

Fan and Motor Removal

Note: Be sure to isolate power before removing the fan.

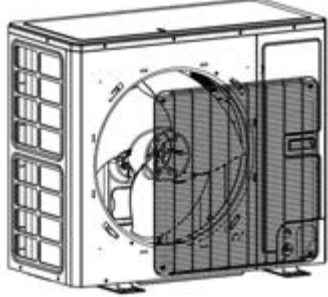
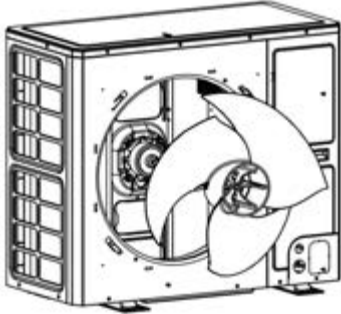
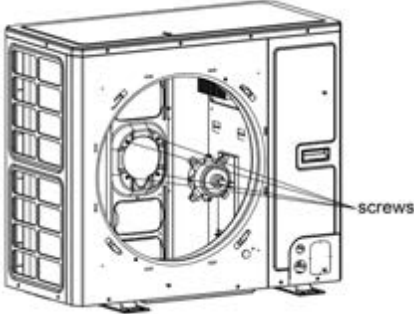
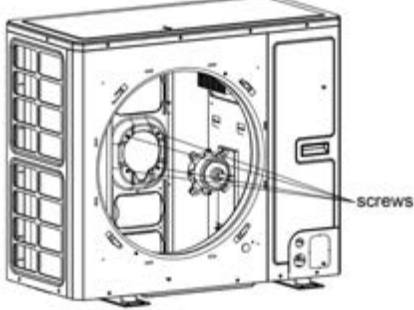
Step	Picture	Work instruction
1. Remove the grill.		Use a screwdriver to unscrew the two screws on the upper left and lower right corners.
2. Remove the fan.		Use a wrench to remove the specialized nut and gasket of the fan. Note: Please keep the nut and gasket safe after removing them from the fan.
3. Remove motor.		Use a screwdriver to unscrew the bolt of motor. Note: Motor wire should be first removed from the electric box.
4. Install the motor.		Replace with a new motor. Then tighten up the screw bolt.

Fan and Motor Removal

Note: Be sure to isolate power before removing the fan.

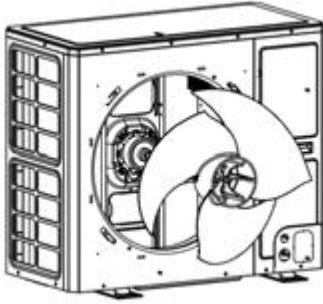
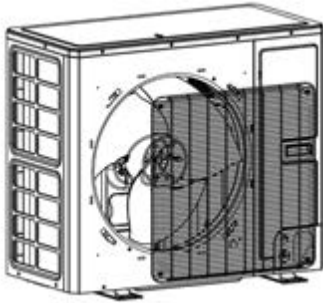
Step	Picture	Work instruction
5. Install the fan.		<p>Install the fan in place. Put on the gasket and use a wrench to secure the screw nut.</p> <p>Note: After installing the fan, turn the fan by hand to see if it can run normally. If not, please check for the reason.</p>
6. Install the grill.		<p>After replacing the motor, use a screwdriver to tighten up the screw bolt that secures the motor. Arrange the wires according to the wiring diagram.</p>

Model: AUH2436ZGDA

Outdoor Coil Removal

Note: Make sure all refrigerant has been recovered and power is isolated before removing the outdoor coil.

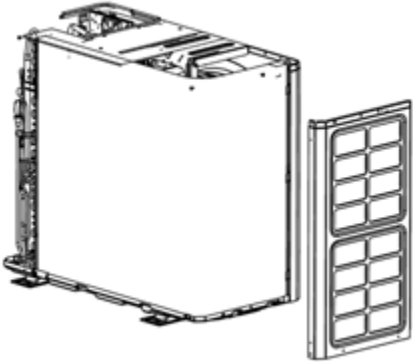
Step	Picture	Work instruction
1. Remove the panels.		<p>Remove the upper, lower and front panels.</p>

Maintenance

Outdoor Coil Removal

Note: Make sure all refrigerant has been recovered and power is isolated before removing the outdoor coil.

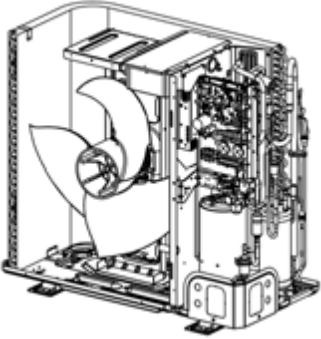
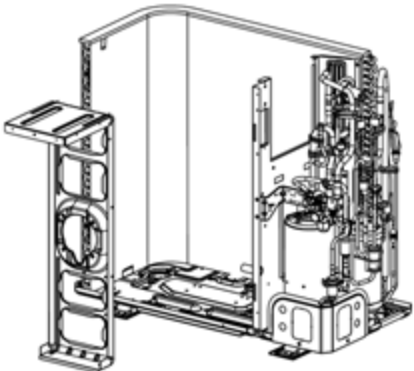
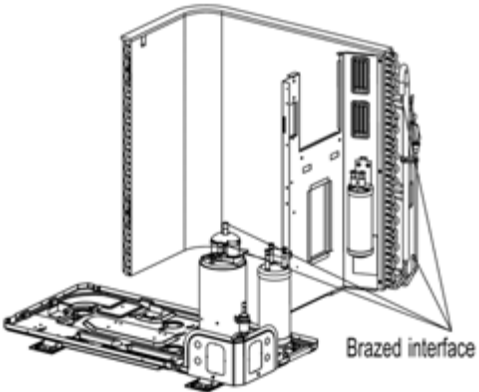
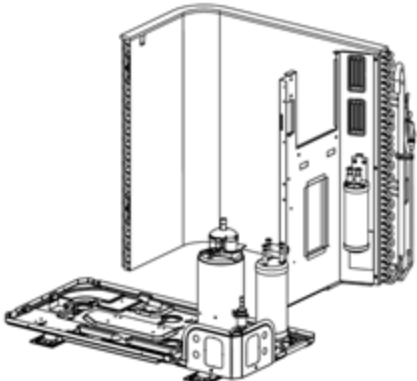
Step	Picture	Work instruction
2. Remove the electric box.		<p>Loosen the wire clamp at the bottom of the electric box.</p> <p>Unscrew the screws of electric box.</p> <p>The connection wires inside and outside the electric box should be removed.</p>
3. Remove motor support.		<p>When removing the motor support, be careful to protect the components.</p>
4. Remove the outdoor coil.	 <p>Brazed interface</p>	<p>Heat the brazed joint with a torch until the pipes separate.</p> <p>Note: When brazing the pipes, do not let the flame burn the other components. The brazing points of the outdoor coil are steel and copper brazed points. Be sure to maintain the brazing quality.</p>
5. Remove the outdoor coil		<p>Loosen the securing screws of coil support. Take off the plate type heat exchanger and the support as a whole.</p>

Outdoor Coil Removal

Note: Make sure all refrigerant has been recovered and power is isolated before removing the outdoor coil.

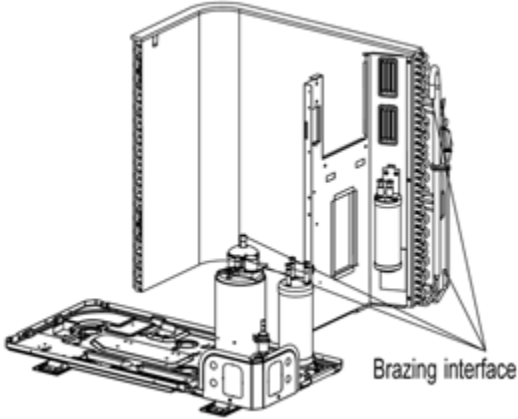
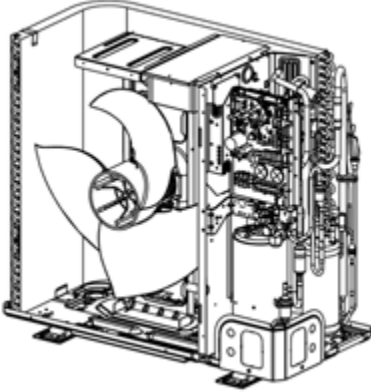
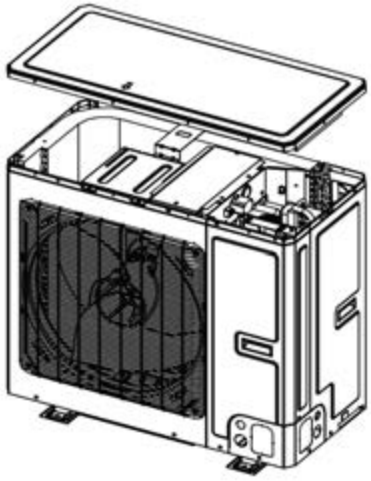
Step	Picture	Work instruction
<p>6. Install the new outdoor coil.</p>		<p>Secure the screws of coil and support. Then fix them together on the chassis.</p> <p>Install the coil by referring to the positions of entering and leaving pipes. Braze the connection pipes.</p> <p>Nitrogen welding: the pressure of nitrogen is 2" to 3" W.C.</p> <p>Note: When brazing the pipes, do not let the flame burn the other components.</p>
<p>7. Secure the electric box and arrange the wires according to the requirement.</p>		<p>Put the electric box in place and tighten up the screws of electric box.</p> <p>Arrange and secure the wires as original.</p>
<p>8. Check and open the upper</p>		<p>Check whether each component and connection wire is well connected.</p> <p>If everything is OK, place back the upper, left and right side panels.</p>

Model: AUH2436ZGDA

Electronic Expansion Valve Removal

Note: Recover all refrigerant and isolate power before removing the electronic expansion valve.

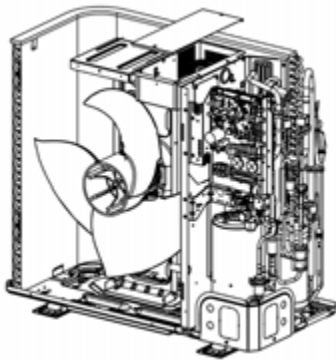
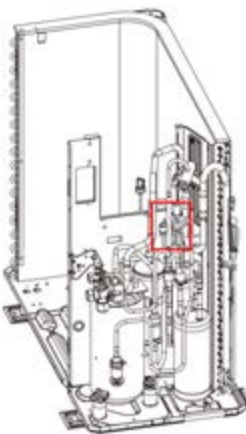
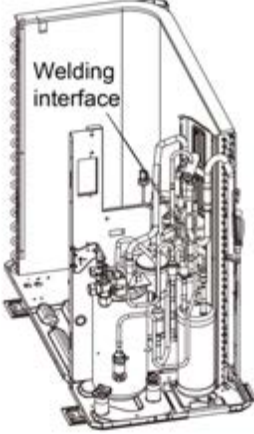
Step	Picture	Work instruction
<p>1. Remove the electric box.</p>		<p>Remove the upper, lower and front panels.</p> <p>Loosen the wire clamp at the bottom of the electric box</p> <p>Unscrew the screws of electric box.</p> <p>The connection wires inside and outside the electric box should be removed.</p> <p>When removing the electric box, be careful to protect the components.</p>
<p>2. Remove the fixed block.</p>		<p>Remove the fixed block between the electronic expansion valve and the pipe.</p>
<p>3. Remove the electronic expansion valve.</p>		<p>Take off the coil of electronic expansion valve.</p> <p>Loosen the connection pipe of electronic expansion valve by brazing. Then remove the connection pipe.</p> <p>Note: When brazing the pipe, do not let the flame bunt the other components.</p>

Electronic Expansion Valve Removal

Note: Recover all refrigerant and isolate power before removing the electronic expansion valve.

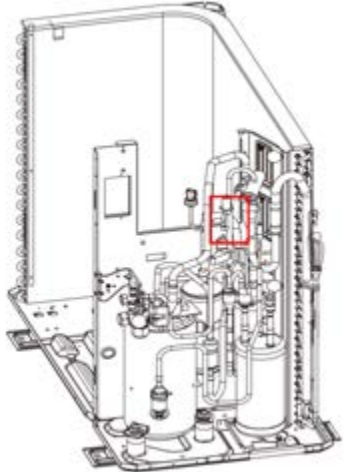
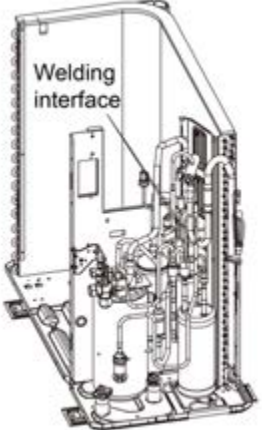
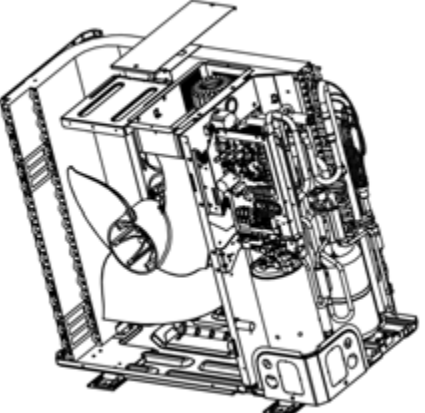
Step	Picture	Work instruction
<p>4. Take out the electronic expansion valve.</p>		<p>Take out the electronic expansion valve.</p>
<p>5. Install the new electronic expansion valve.</p>		<p>Braze the connection pipe of electronic expansion valve.</p> <p>When brazing the electronic expansion valve, the valve should be wrapped with wet cloth.</p> <p>Nitrogen brazing: the pressure of nitrogen is 2" to 3" W.C.</p> <p>Note: When brazing the pipes, do not let the flame burn the other components.</p> <p>Install the coil of electronic expansion valve.</p>
<p>6. Secure the electric box and arrange the wires as required.</p>		<p>Put the electric box back in place and tighten up the screws.</p> <p>Arrange the wires as original.</p>

Maintenance

Electronic Expansion Valve Removal

Note: Recover all refrigerant and isolate power before removing the electronic expansion valve.

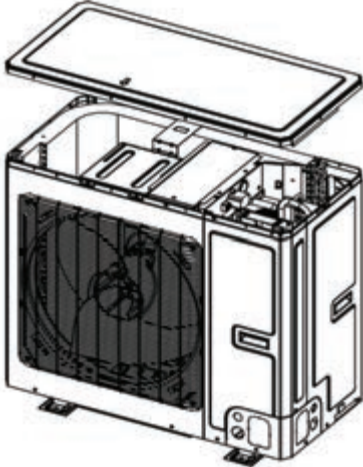
Step	Picture	Work instruction
<p>7. Check and open the upper and front panels.</p>		<p>Check whether each component and connection wire is well connected.</p> <p>If everything is OK, install the upper, left and right panels. Tighten up the screws.</p>

Model: AUH4860ZGDA

Front Panel Removal

Note: Be sure power is isolated before removing front panel.

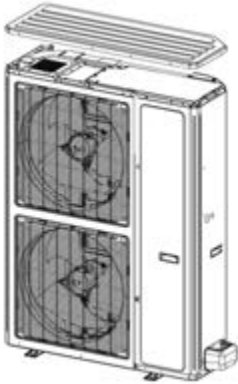
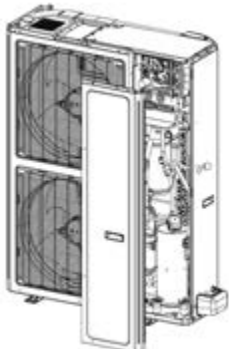
Step	Picture	Work instruction
<p>1. Remove the upper cover plate.</p>		<p>Unscrew the screws of the upper cover plate with a screwdriver.</p>
<p>2. Remove the front plate.</p>		<p>Unscrew the screws of the front plate with a screwdriver.</p>

Front Panel Removal

Note: Be sure power is isolated before removing front panel.

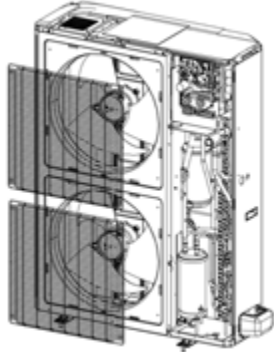
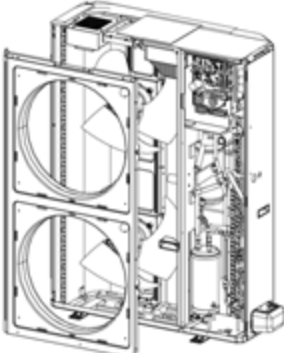
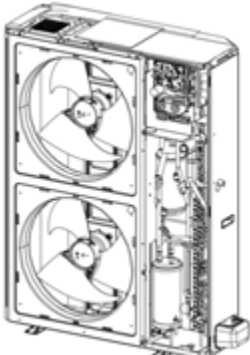
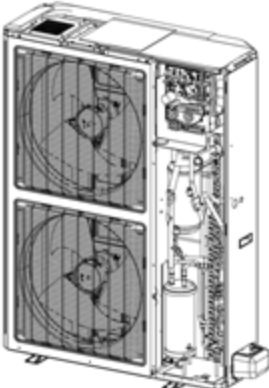
Step	Picture	Work instruction
3. Remove the front grill.		<p>Unscrew the screws of the front grill with a screwdriver.</p>
4. Remove the front panel.		<p>Unscrew the screws that connect the front panel to the middle insulating board and screws around the front panel.</p>
5. Install the front panel.		<p>Install the front panel by mounting on 6 clasps on its both sides. Please note that there is one screw on the lower right side.</p>
6. Install the grill.		<p>Attach the grill back in place and tighten up the screws.</p>

Maintenance

Front Panel Removal

Note: Be sure power is isolated before removing front panel.

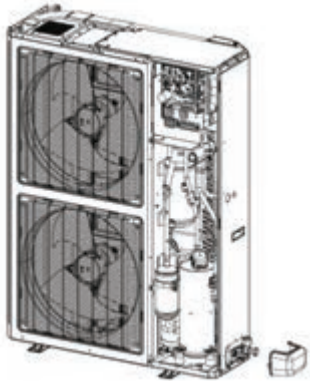
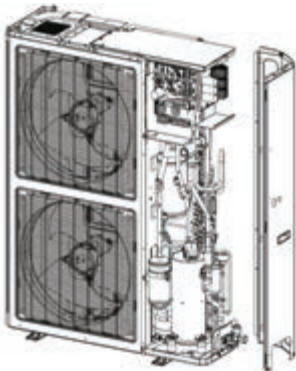
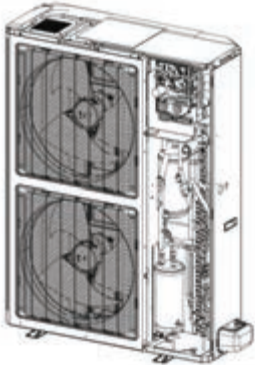
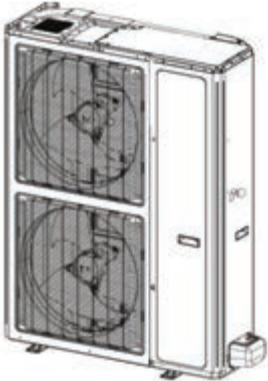
Step	Picture	Work instruction
7. Remove the valve cover		Unscrew the screws of the valve cover with a screwdriver.
8. Remove the right side plate.		Unscrew the screws that connect the right side plate to the electric box and the screws around the right side plate.
9. Install the right side plate.		Screw up the screws around the right side plate. Be careful to handle well the clasps at the bottom of the right side plate.
10. Install the grill.		Attach the grill back in place and tighten up the screws.

Front Panel Removal

Note: Be sure power is isolated before removing front panel.

Step	Picture	Work instruction
11. Install the upper cover plate.		Tighten up the screws around the upper cover plate.

Model: AUH4860ZGDA

Compressor Disassembly

Note: Be sure the refrigerant is recovered and power is isolated before removing the compressor.

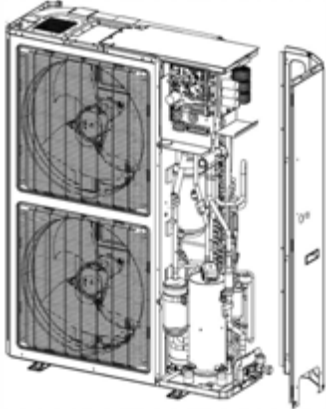
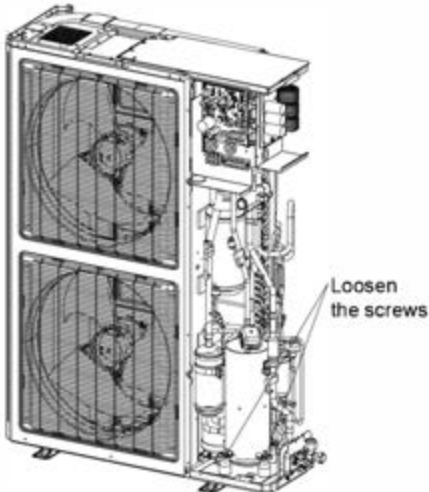
Step	Picture	Work instruction
1. Remove wires.		<p>Loosen the securing screws of the wires with a screwdriver.</p> <p>Remove the wires.</p> <p>Note: When removing the wires, mark the wire terminals corresponding to their color so as to avoid misconnection.</p>
2. Loosen the securing screws at the foot of compressor.		Use a wrench to twist off the screw nuts at the foot of compressor.

Compressor Disassembly

Note: Be sure the refrigerant is recovered and power is isolated before removing the compressor.

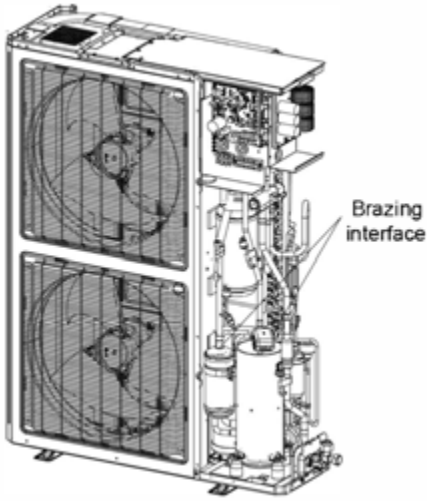
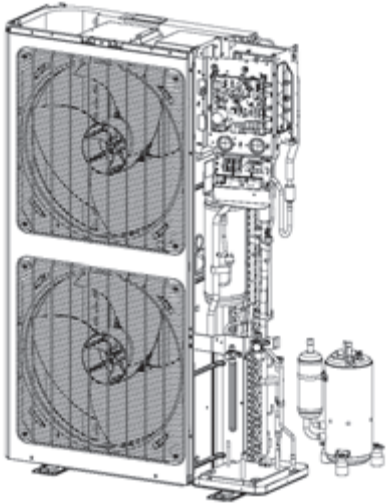
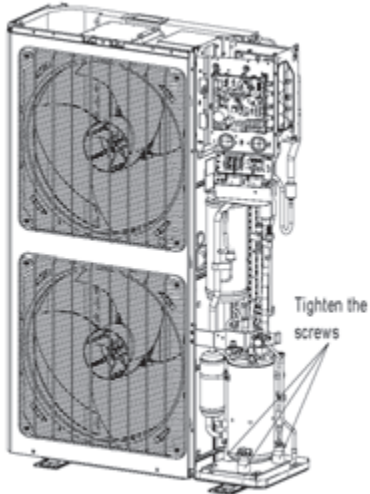
Step	Picture	Work instruction
<p>3. Break off the pipes that connect to the compressor.</p>		<p>Braze the pipes that are connected to the compressor.</p> <p>Then remove the pipes.</p> <p>Note: When brazing the pipes, do not let the flame burn the other components</p>
<p>4. Remove the compressor from the chassis</p>		<p>Take out the compressor and replace it.</p> <p>Note: When replacing the compressor, avoid touching the nearby pipeline and components.</p>
<p>5. Fix the new compressor back onto the chassis.</p>		<p>After replacing the compressor, tighten up the screws at the foot of compressor.</p>

Compressor Disassembly

Note: Be sure the refrigerant is recovered and power is isolated before removing the compressor.

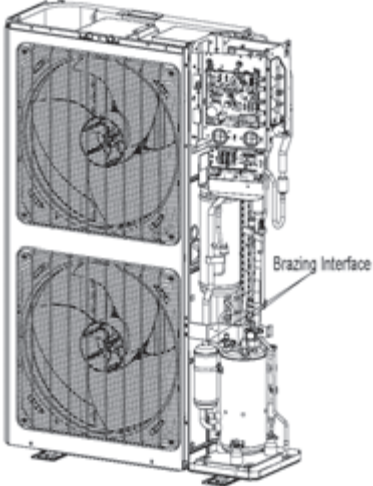
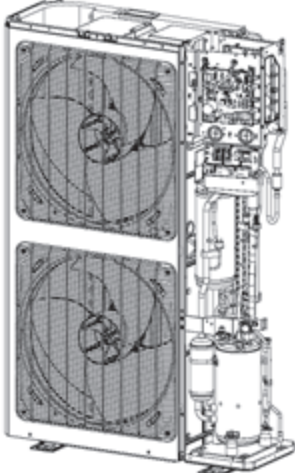
Step	Picture	Work instruction
<p>6. Connect the pipes to the suction and discharge ports.</p>		<p>Braze the compressor connection pipes and connect them to the compressor.</p> <p>Note: When replacing the compressor, avoid touching the nearby pipeline and components.</p>
<p>7. Connect the compressor</p>		<p>Connect the compressor wires to the wire terminals on the top of compressor.</p> <p>Note: When connecting the wires, be sure to match the colors with the corresponding wire terminals.</p>

4-Way Valve Removal

Note: Make sure refrigerant is fully recovered and power is isolated before removing the 4-way valve.

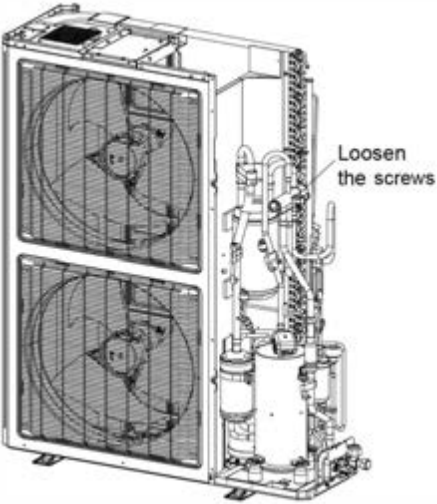
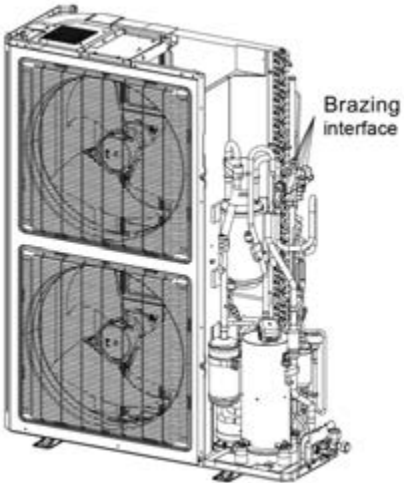
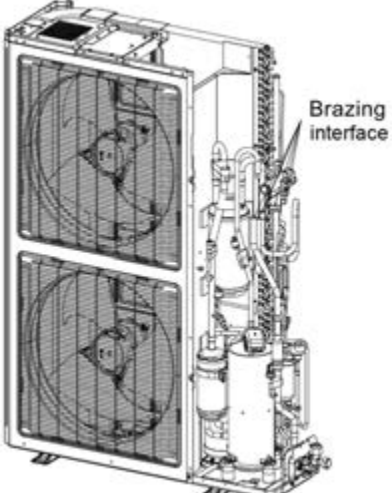
Step	Picture	Work instruction
<p>1. Remove the solenoid coil from the 4-way valve</p>		<p>Carefully unscrew the screws of electromagnetic coil with a screwdriver.</p>
<p>2. Break off the connection pipes from the 4-way valve.</p>		<p>Use a torch to loosen the 4 joints on the 4-way valve and then remove the connection pipes.</p> <p>Note: When brazing the pipes, the 4-way valve should be wrapped with wet cloth for cooling. Do not let the flame burn the other components.</p>
<p>3. Replace the 4-way valve and connect it to the connection pipes.</p>		<p>Replace the 4-way valve and then use a torch to braze the 4 joints of the 4-way valve.</p> <p>Note: When brazing the pipes, the 4-way valve should be wrapped with wet cloth for cooling. Do not let the flame burn the other components.</p>

4-Way Valve Removal

Note: Make sure refrigerant is fully recovered and power is isolated before removing the 4-way valve.

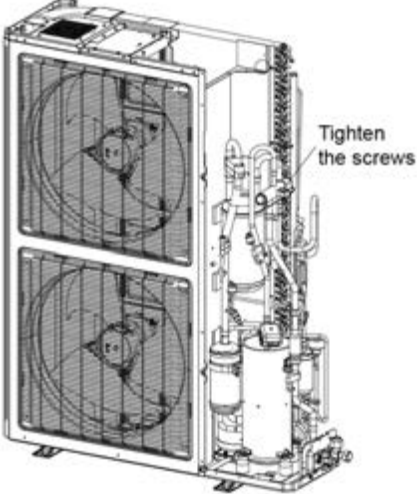
Step	Picture	Work instruction
<p>4. Install the coil of 4-way valve.</p>		<p>Tighten the screws of the coil of 4-way valve with a screwdriver.</p>

Model: AUH4860ZGDA

Fan and Motor Removal

Note: Be sure to isolate power before removing the fan.

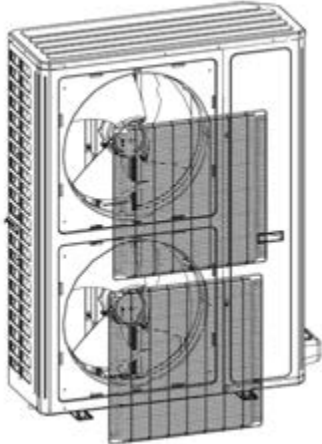
Step	Picture	Work instruction
<p>1. Remove the grill.</p>		<p>Use a screwdriver to unscrew the two screws on the upper left and lower right corners.</p>

Fan and Motor Removal

Note: Be sure to isolate power before removing the fan.

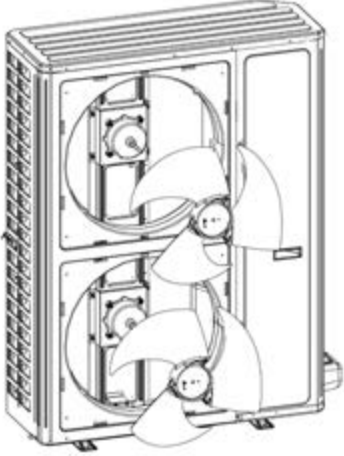
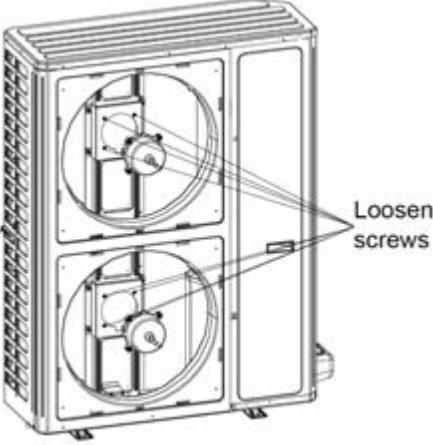
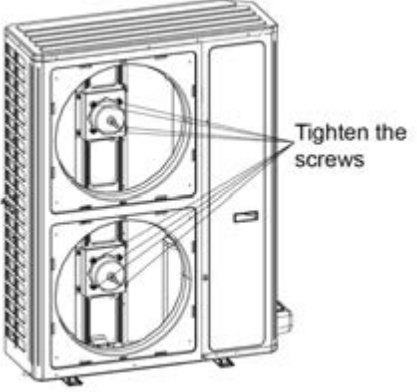
Step	Picture	Work instruction
<p>2. Remove the fan.</p>		<p>Use a wrench to remove the specialized nut and gasket of the fan.</p> <p>Note: Please keep the nut and gasket safe after removing them from the fan.</p>
<p>3. Remove motor.</p>		<p>Use a screwdriver to unscrew the bolt of motor.</p> <p>Note: Motor wire should be first removed from the electric box.</p>
<p>4. Install the motor.</p>		<p>Replace with a new motor. Then tighten up the screw bolt.</p>

Fan and Motor Removal

Note: Be sure to isolate power before removing the fan.

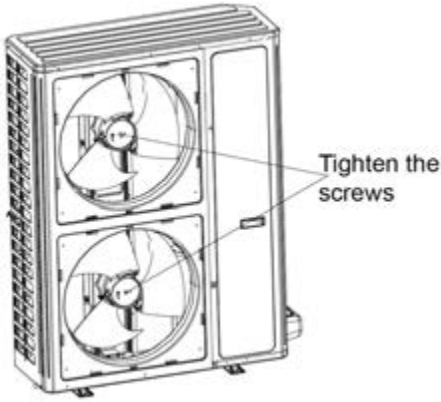
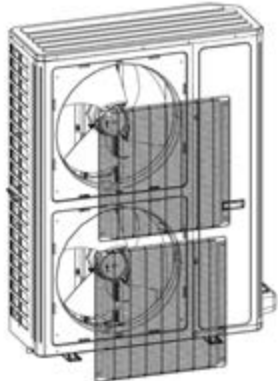
Step	Picture	Work instruction
<p>5. Install the fan.</p>		<p>Install the fan in place. Put on the gasket and use a wrench to secure the screw nut.</p> <p>Note: After installing the fan, turn the fan by hand to see if it can run normally. If not, please check for the reason.</p>
<p>6. Install the grill.</p>		<p>After replacing the motor, use a screwdriver to tighten up the screw bolt that secures the motor. Arrange the wires according to the wiring diagram.</p>

Model: AUH4860ZGDA

Compressor/Gas Liquid Separator Removal

Note: Be sure power is isolated and refrigerant is recovered before removing the gas liquid separator.

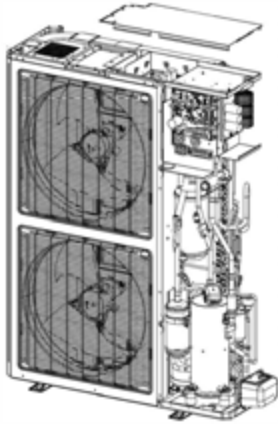
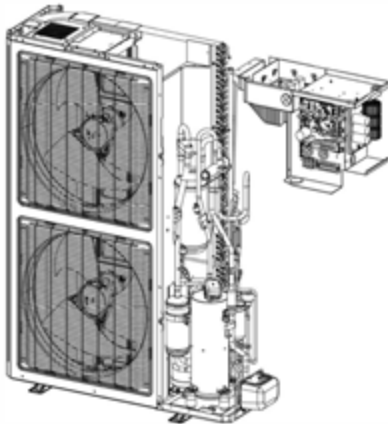
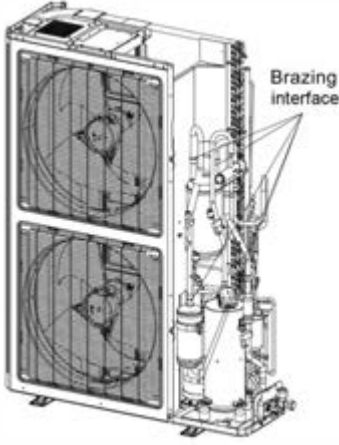
Step	Picture	Work instruction
<p>1. Loosen the wire clamp at the bottom of the electric box and the screws of electric box.</p>		<p>Remove the upper, lower and front panels.</p> <p>Loosen the wire clamp at the bottom of the electric box.</p> <p>Unscrew the screws of electric box.</p>
<p>2. Remove the electric box.</p>		<p>The connection wires inside and outside the electric box should be removed.</p> <p>When removing the electric box, be careful to protect the components.</p>
<p>3. Remove the compressor/gas liquid separator from the chassis.</p>		<p>Remove the compressor/gas liquid separator and replace with a new one.</p> <p>Note: When replacing the compressor/gas liquid separator, avoid touching the nearby pipeline and components.</p>

Compressor/Gas Liquid Separator Removal

Note: Be sure power is isolated and refrigerant is recovered before removing the gas liquid separator.

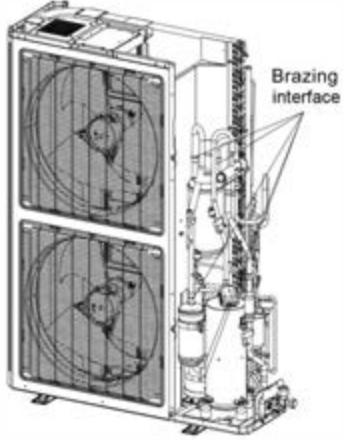
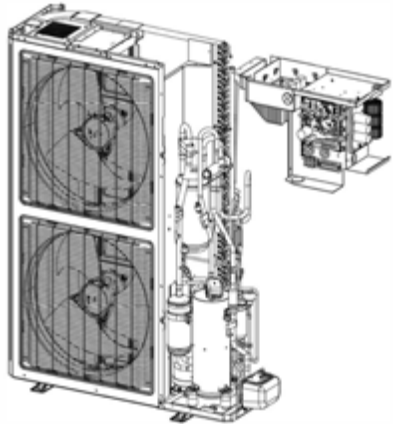
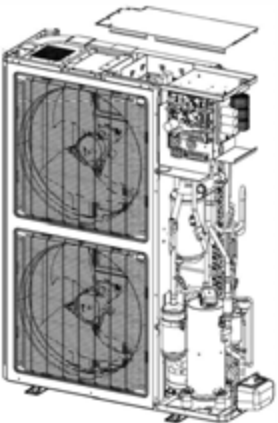
Step	Picture	Work instruction
<p>4. Install the new gas liquid separator</p>		<p>Install the gas liquid separator by referring to the positions of entering and leaving pipes. Braze the two joints</p> <p>Nitrogen welding: the pressure of nitrogen is 2" to 3" W.C</p> <p>Note: When brazing the pipes, do not let the flame burn the other components.</p> <p>Tighten the screws of gas liquid separator.</p>
<p>5. Secure the electric box and</p>		<p>Put the electric box back in place and tighten up the screws.</p> <p>Arrange the wires as original.</p>
<p>6. Check and open the upper and side panels.</p>		<p>Check whether each component and connection wire is well connected.</p> <p>If everything is OK, install the upper, left and right panels. Tighten up the screws.</p>

Model: AUH4860ZGDA

Electronic Expansion Valve Removal

Note: Be sure power is isolated and refrigerant is recovered before removing the Electronic Expansion Valve

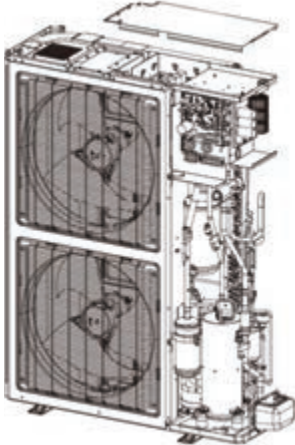
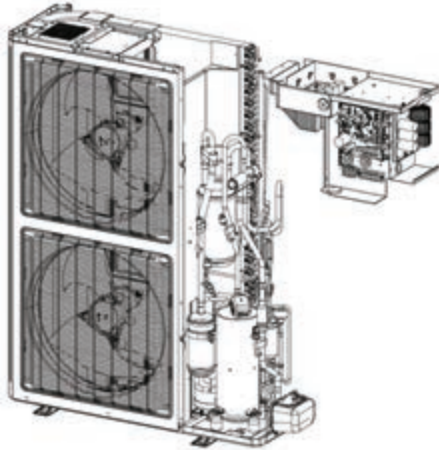
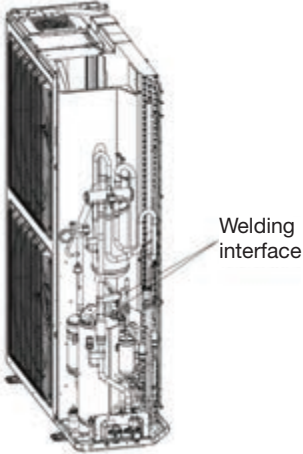
Step	Picture	Work instruction
<p>1. Loosen the wire clamp at the bottom of the electric box and the screws of electric box.</p>		<p>Remove the upper, lower and front panels.</p> <p>Loosen the wire clamp at the bottom of the electric box.</p> <p>Unscrew the screws of electric box.</p>
<p>2. Remove the electric box.</p>		<p>The connection wires inside and outside the electric box should be removed.</p> <p>When removing the electric box, be careful to protect the components.</p>
<p>3. Remove the electronic expansion valve.</p>		<p>Take off the coil of electronic expansion valve.</p> <p>Loosen the connection pipe of electronic expansion valve using a torch. Remove the connection pipe.</p> <p>Note: When brazing the pipe, do not let the flame burn the other components.</p>

Electronic Expansion Valve Removal

Note: Be sure power is isolated and refrigerant is recovered before removing the Electronic Expansion Valve

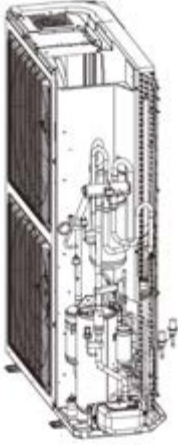
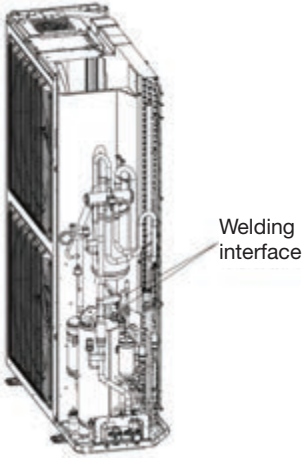
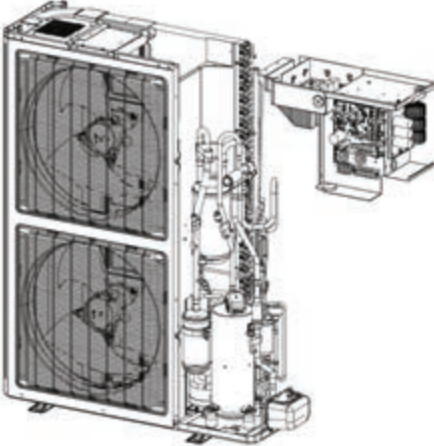
Step	Picture	Work instruction
<p>4. Take out the electronic expansion valve.</p>		<p>Take out the electronic expansion valve.</p>
<p>5. Install the new electronic expansion valve.</p>		<p>Braze the connection pipe of electronic expansion valve.</p> <p>When brazing the electronic expansion valve, the valve should be wrapped with wet cloth.</p> <p>Nitrogen welding: the pressure of nitrogen is 2" to 3" W.C.</p> <p>Note: When brazing the pipes, do not let the flame burn the other components.</p> <p>Install the coil of electronic expansion valve.</p>
<p>6. Secure the electric box and arrange the wires as required.</p>		<p>Put the electric box back in place and tighten up the screws.</p> <p>Arrange the wires as original.</p>

Maintenance

Electronic Expansion Valve Removal

Note: Be sure power is isolated and refrigerant is recovered before removing the Electronic Expansion Valve

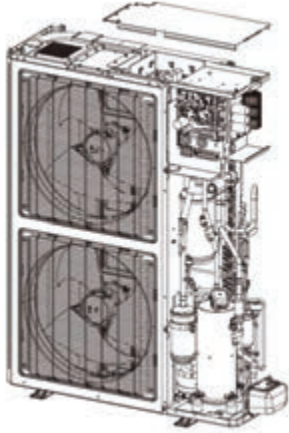
Step	Picture	Work instruction
<p>7. Check and open the upper and side panels.</p>		<p>Check whether each component and connection wire is well connected.</p> <p>If everything is OK, install the upper, left and right panels. Tighten up the screws.</p>

Removal of IDU Major Components

Air handler Unit

Electric Box Disassembly and Assembly

Note: Be sure power is isolated and refrigerant is recovered before removing the Electronic Expansion Valve

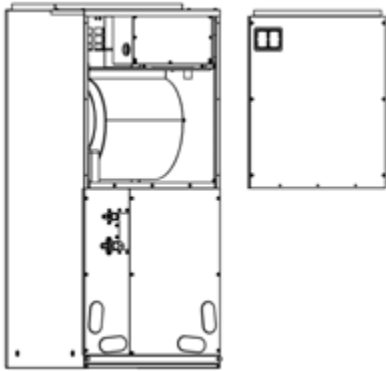
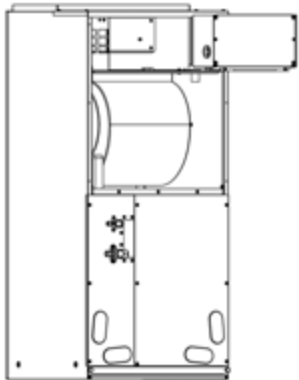
Step	Picture	Work instruction
<p>1. Remove the upper panel</p>		<p>Loosen screws around the upper panel with a screwdriver.</p> <p>Remove the upper panel away from the unit.</p>
<p>2. Remove the electric box.</p>		<p>Disconnect the power cord and control line from the wiring terminals, and then draw them out.</p> <p>Loosen screws around the electric box with a screwdriver.</p> <p>Remove the electric box from the unit.</p>

Electric Box Disassembly and Assembly

Note: Be sure power is isolated and refrigerant is recovered before removing the Electronic Expansion Valve

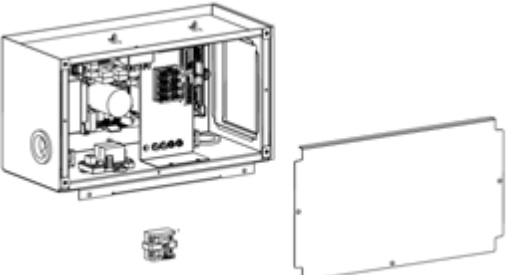
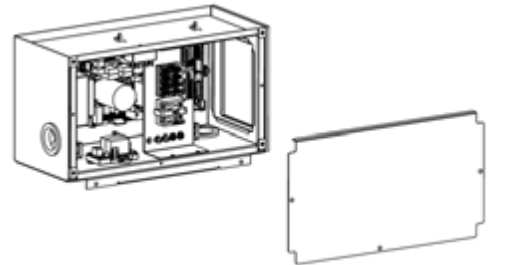
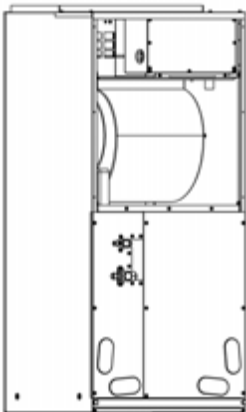
Step	Picture	Work instruction
<p>3. Remove the electric element.</p>		<p>Disconnect the electric element from the wiring terminal.</p> <p>Loosen screws around the electric element with a screwdriver.</p> <p>Remove the electric element from the electric box.</p>
<p>4. Mount the new electric element.</p>		<p>Place the electric element at the proper position.</p> <p>Tighten the screws around the electric element with a screwdriver.</p> <p>Wire the electric element to the wiring terminal.</p>
<p>5. Reinstall the electric box.</p>		<p>Place the electric box at the proper position.</p> <p>Tighten screws around the electric box with a screwdriver.</p> <p>Connect the power cord and control line properly.</p> <p>Reassemble the unit as before.</p>

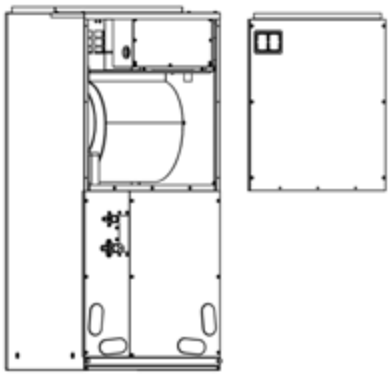
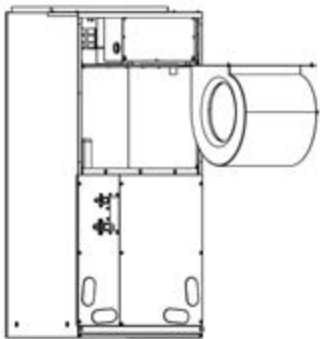
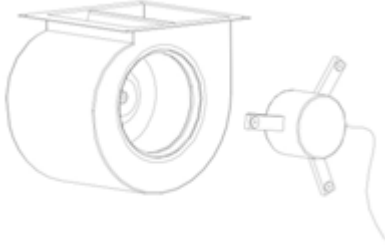
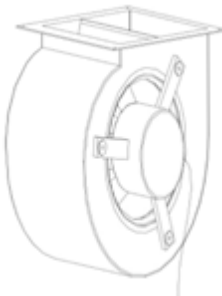
Fan Motor Disassembly and Assembly		
Step	Picture	Work instruction
1. Remove the upper panel.		Loosen screws round the upper panel with a screwdriver. Remove the upper panel from unit.
2. Remove the fan.		Disconnect the wires of the fan from the wiring terminal and draw them out. Loosen screws located at the front of the fan with a screwdriver. Remove the fan from the unit.
3. Remove the motor.		Disconnect the wires of the fan from the wiring terminal and draw them out. Loosen screws located at the front of the fan with a screwdriver. Remove the fan from the unit.
4. Reinstall the fan.		Place the motor at the proper position. Tighten screws fixing the motor and fan wheel. Tighten screw bolts fixing the motor bracket. After the installation, reassemble the unit as before.

Indoor Coil And Drain Pan Disassembly and Assembly

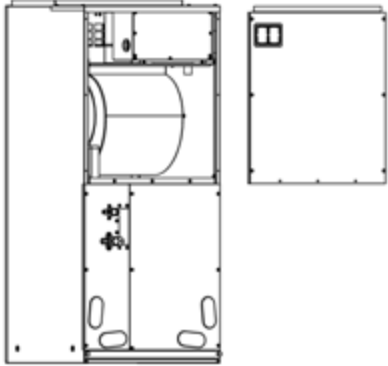
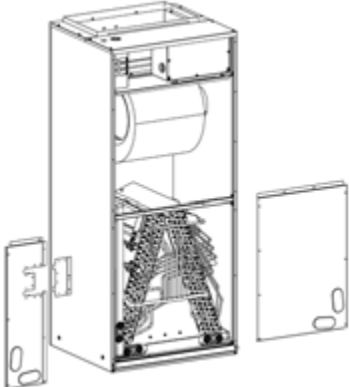
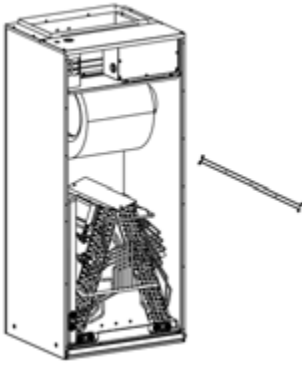
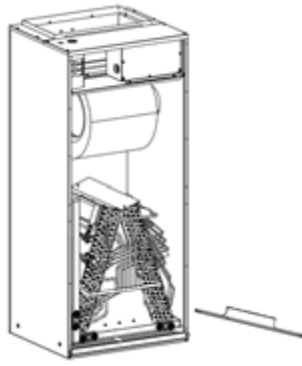
Step	Picture	Work instruction
<p>1. Remove the upper panel.</p>		<p>Loosen screws round the upper panel with a screwdriver.</p> <p>Remove the upper panel from unit</p>
<p>2. Remove the lower panel (1) and panel (2).</p>		<p>Loosen screws round the lower panel with a screwdriver.</p> <p>Remove the lower panel from unit.</p>
<p>3. Remove the enhanced frame if applicable.</p>		<p>Remove the screws from enhanced frame.</p> <p>Disassemble the enhanced frame from the unit.</p>
<p>4. Remove the mounting plate of the drain pan.</p>		<p>Loosen screws at both side of the mounting plate with a screwdriver.</p> <p>Remove the mounting plate from the unit.</p>

Maintenance

Indoor Coil And Drain Pan Disassembly and Assembly

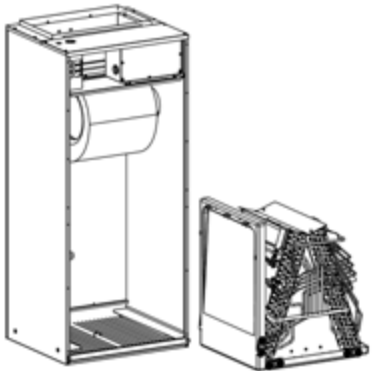
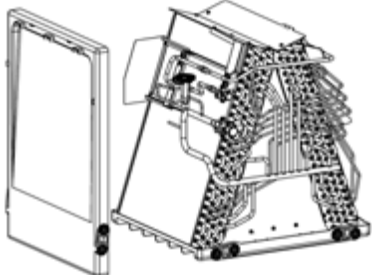
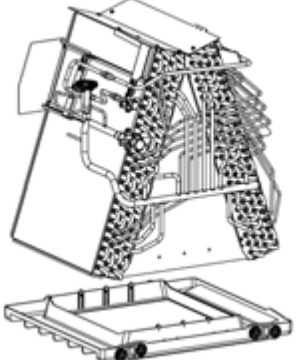
Step	Picture	Work instruction
<p>5. Remove the primary drain pan.</p>		<p>Remove the primary drain pan from the unit.</p>
<p>6. Remove the secondary drain pan.</p>		<p>Remove the secondary drain pan from the unit.</p>
<p>7. Remove the coil.</p>		<p>Remove the coil away from the primary drain pan.</p> <p>Reassemble the unit as before.</p>

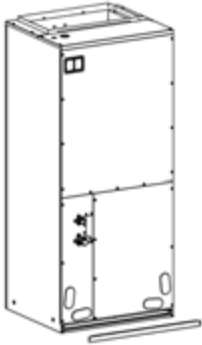
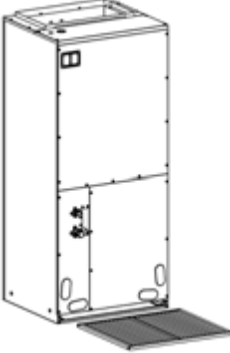
Filter Disassembly and Assembly		
Step	Picture	Work instruction
1. Remove the mounting plate		Loosen screws fixing the mounting plate. Remove the mounting plate away from the unit
2. Remove the filter screen		Remove the filter screen away from the unit. After replacing the filter screen, reassemble the unit as before.

Maintenance

Exploded View and Parts Lists

ODU Exploded View and Parts Lists

AUH2436ZGDA

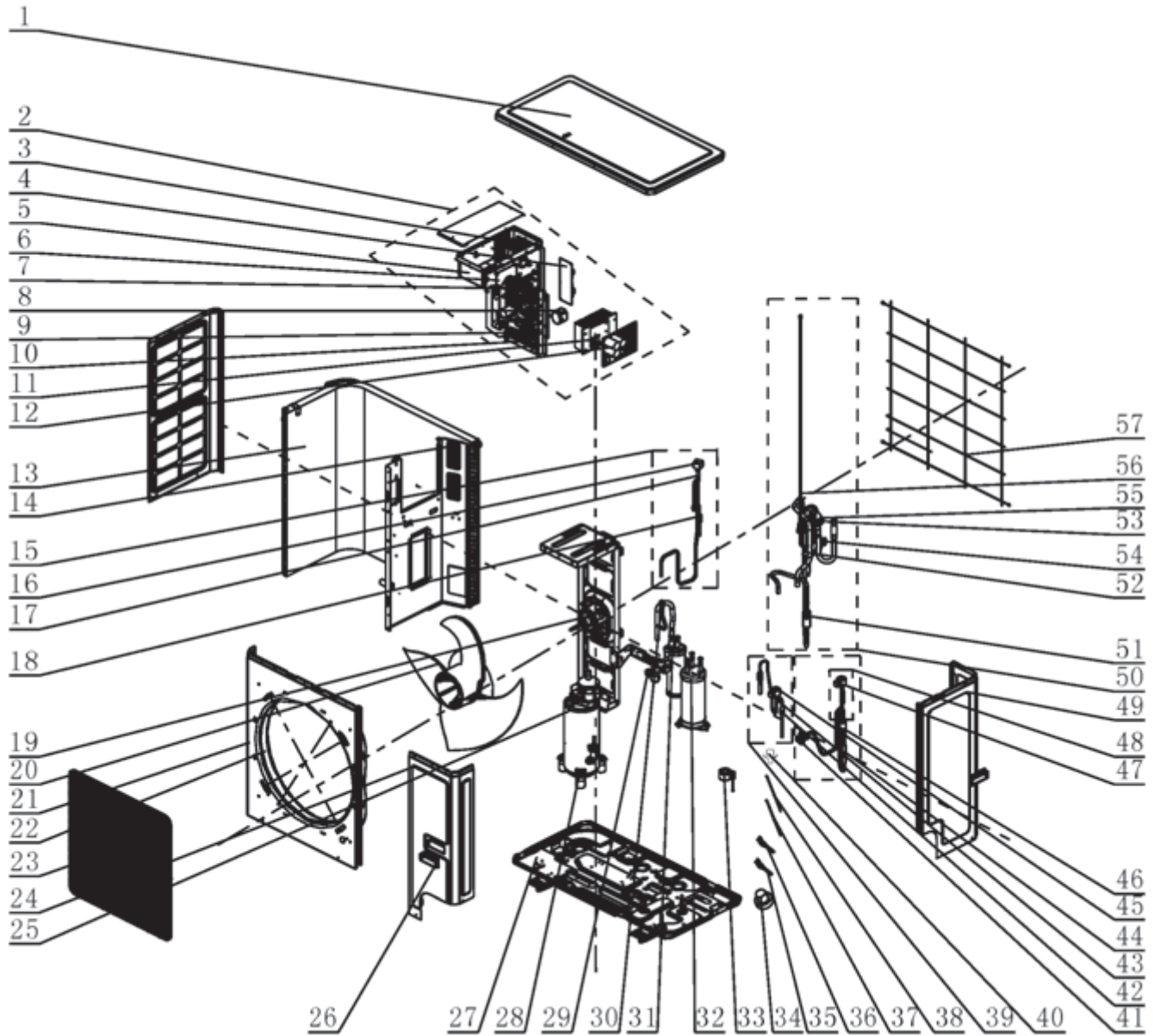

No.	Material name
1	Coping
2	Electric Box Assembly
3	PFC Inductance
4	Filter Board
5	Reactor Sub-Assembly
6	Power Switch
7	Main Board
8	Inductance
9	Terminal Board
10	Terminal Board
11	Heat Sink
12	Main Board
13	Coil Assembly
14	Filter Sub-Assembly
15	Electromagnetic Valve Sub-Assembly
16	Magnet Coil (Electromagnetic Valve)
17	Electromagnetic Valve
18	Strainer
19	Brushless DC Motor
20	Axial Flow Fan
21	Cabinet
22	Diversion Circle
23	Front Grill
24	Front Side Plate
25	Compressor And Fittings
26	Handle
27	Chassis Assembly
28	Foot
29	Cut Off Valve

No.	Material name
30	Fusible Plug
31	Gas-liquid Separator
32	Accumulator
33	4 Way Valve Coil
34	Drainage Hole Cap
35	Temperature Sensor
36	Temperature Sensor
37	Electrical Heater(Compressor)
38	Electrical Heater (Chassis)
39	Electric Expansion Valve Sub-Assembly
40	Drainage Joint
41	Cut-Off Valve 3/8(N)
42	Strainer
43	Electric Expand Valve Fitting
44	One Way Valve
45	Electronic Expansion Valve
46	Strainer
47	Electric Expand Valve Fitting
48	Electric Expansion Valve Sub-Assembly
49	Rear Side Plate
50	4-Way Valve Assembly
51	Silencer
52	Pressure Protect Switch
53	Filter
54	Pressure Protect Switch
55	4-Way Valve
56	Pressure Sensor
57	Rear Grill

Maintenance

AUH4860ZGDA

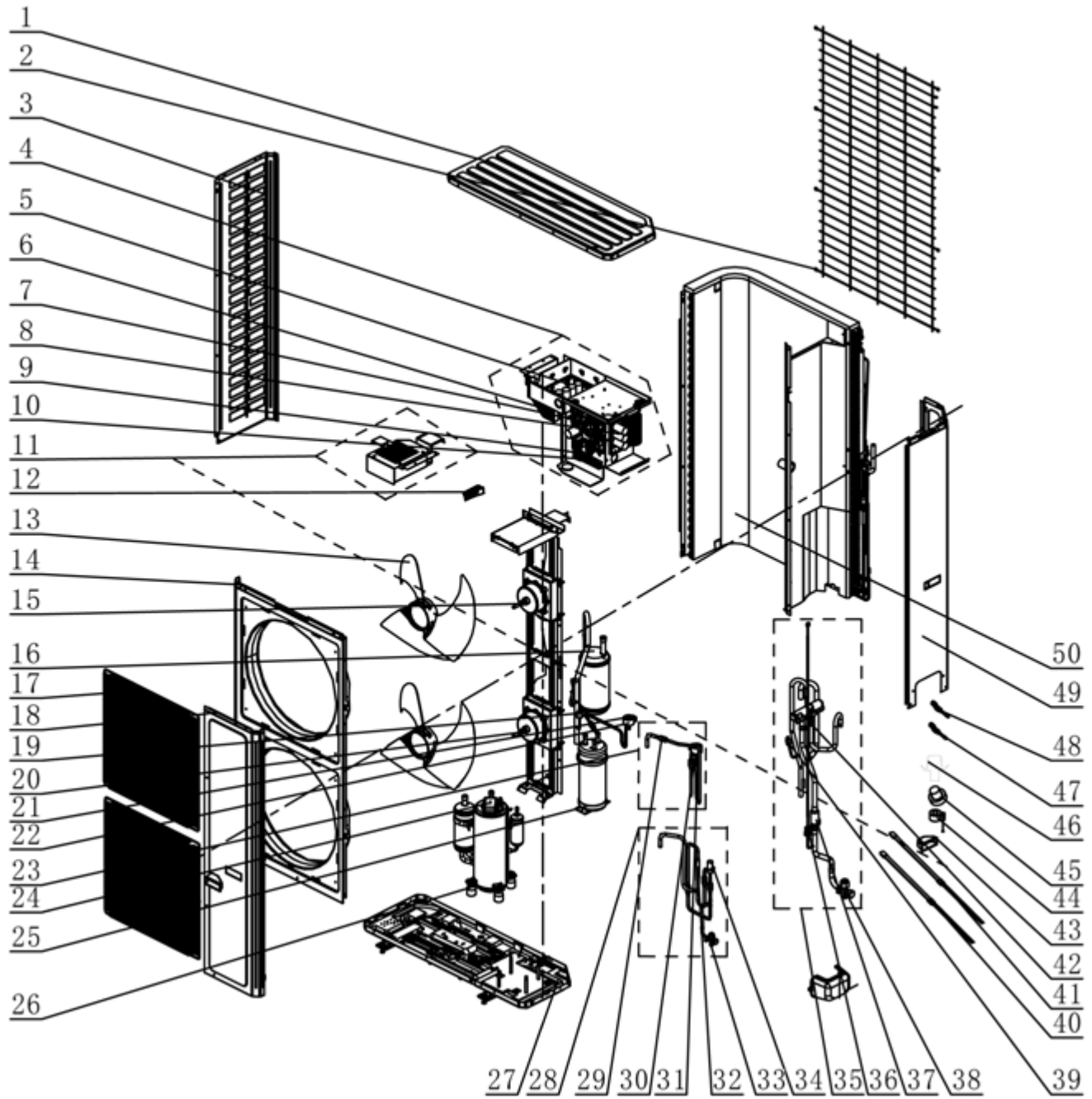

No.	Material name
1	Coping
2	Rear Grill
3	Left Side Plate
4	Electric Box Assembly
5	Drive Board
6	Radiator
7	Main Board
8	Filter Board
9	Terminal Board
10	Terminal Board
11	Inductance Box Assembly
12	Handle
13	Axial Flow Fan
14	Cabinet
15	Brushless DC Motor
16	Gas-liquid Separator Sub-Assembly
17	Front Grill
18	Front Side Plate
19	Pressure Protect Switch
20	Brushless DC Motor
21	Electromagnetic Valve
22	Electric Expand Valve Fitting
23	Electric Expansion Valve Sub-Assembly
24	Compressor and Fittings
25	Accumulator

No.	Material name
26	Foot
27	Chassis Sub-Assembly
28	Cut Off Valve Sub-Assembly
29	Strainer
30	Magnet Coil (Electromagnetic Valve)
31	Electric Expand Valve Fitting
32	One Way Valve
33	Cut-off Valve
34	Electronic Expansion Valve
35	4-Way Valve Assembly
36	Pressure Sensor
37	Strainer
38	Cut Off Valve 3/8
39	Pressure Protect Switch
40	Electrical Heater(Compressor)
41	Electrical Heater(Compressor)
42	4-Way Valve
43	Handle
44	4 Way Valve Coil
45	Drainage Hole Cap
46	Drainage Joint
47	Temperature Sensor
48	Temperature Sensor
49	Rear Side Plate Sub-Assembly
50	Coil Assembly

Maintenance

IDU Exploded View and Parts Lists

UUY24ZGDAA, UUY36ZGDAA

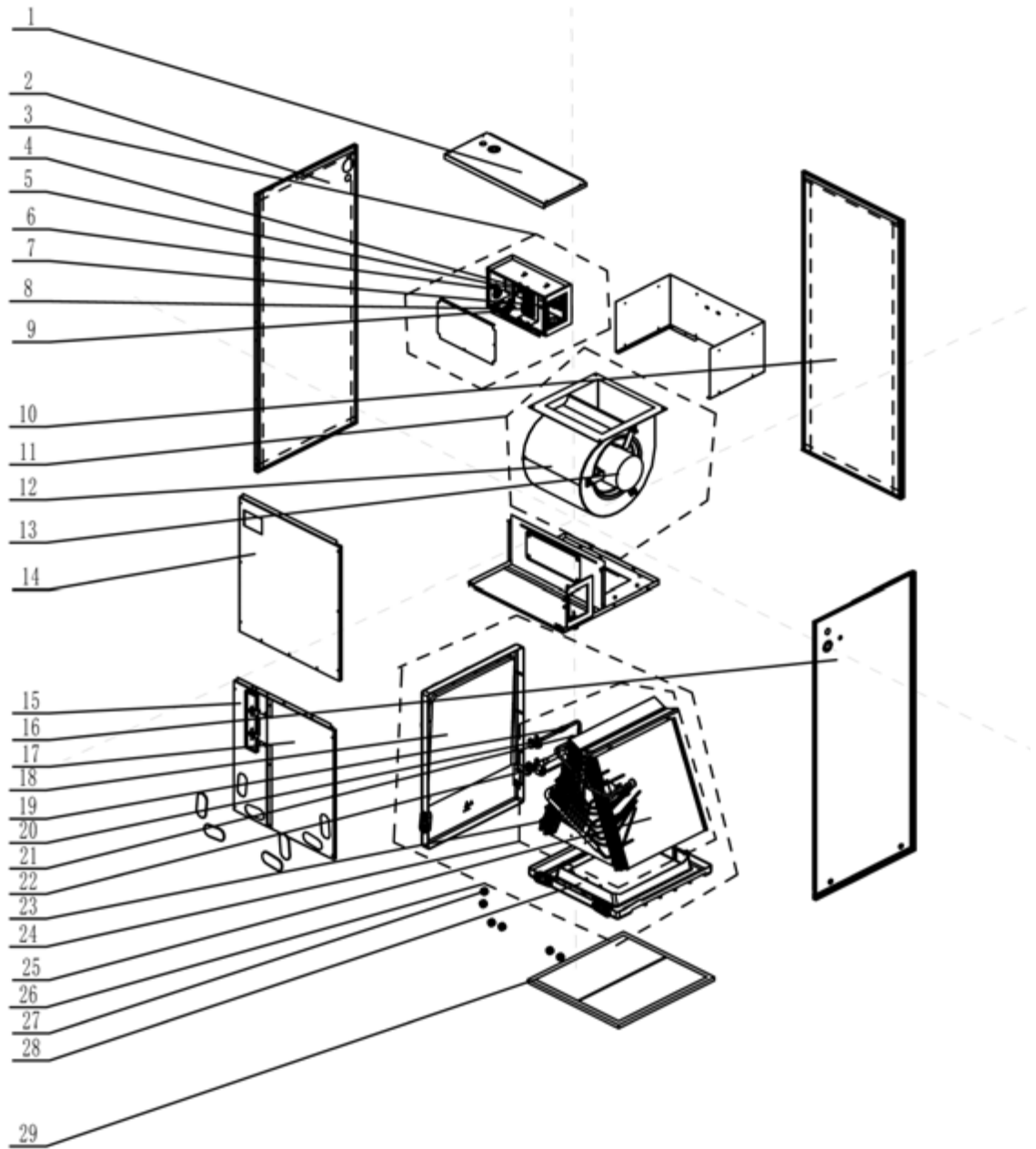

No.	Material name
1	Coping
2	Left Side Plate
3	Electric Box Assembly
4	Terminal Board
5	Transformer
6	Terminal Board
7	Main Board
8	Terminal Board
9	Pinboard
10	Rear Side Plate
11	Centrifugal Fan Assembly
12	Motor For Centrifugal Fan
13	Brushless DC Motor
14	Top Cover Board Sub-Assembly
15	Bottom Cover Plate Assembly
16	Right Side Plate
17	Bottom Cover Plate Assembly
18	Water Tray
19	Strainer
20	Cut-Off Valve 3/8(N)
21	Thermal Expansion Valve
22	Cut Off Valve
23	Evaporator Assembly
24	Evaporator Assembly
25	Evaporator Assembly
26	Water Tray Assembly
27	Choke Plug
28	Water Tray
29	Filter Sub-Assembly

UUY36ZGDAB, UUY60ZGDAB

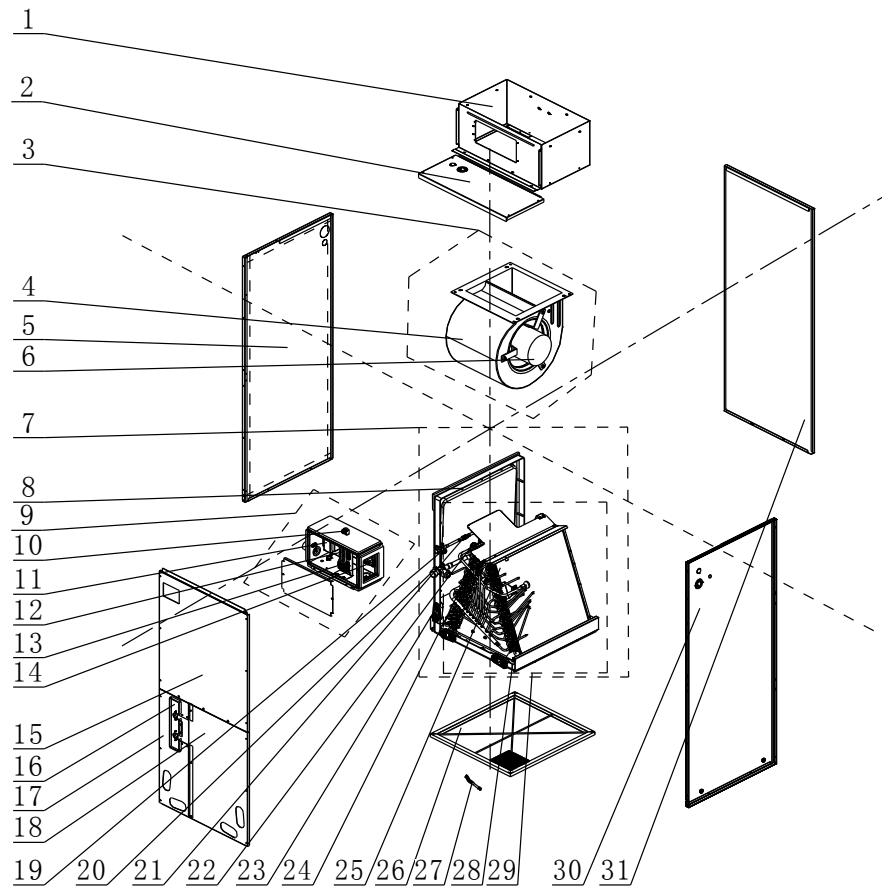

No.	Material name
1	Side Plate
2	Top Cover Sub-Assembly
3	Centrifugal Fan Assembly
4	Motor for Centrifugal Fan
5	Brushless DC Motor
6	Left Side Plate Sub-Assembly
7	Water Tray Assembly
8	Water Tray
9	Electric Box Assembly
10	Terminal Board
11	Transformer
12	Terminal Board
13	Terminal Board
14	Main Board
15	Top Cover Board Sub-Assembly
16	Bottom Cover Plate Assembly

No.	Material name
17	Bottom Cover Plate Assembly
18	Lower Cover Plate Sub-Assembly 2
19	Cut-off Valve 3/8(N)
20	Thermal Expansion Valve
21	Cut off Valve
22	Strainer
23	Choke Plug
24	Evaporator Assembly
25	Evaporator Assembly
26	Filter Sub-Assembly
27	Temperature Sensor
28	Evaporator Assembly
29	Water Tray
30	Right Side Plate
31	Rear Side Plate Sub-Assembly

Temperature Sensor Temperature/Resistance/Voltage Lists

15 K Ω Temperature Sensors (including ODU temperature sensors)

F°	C°	Resistance (k Ω)	Voltage (V)
-4.0	-20	144	0.311
-2.2	-19	138.1	0.323
-0.4	-18	128.6	0.345
1.4	-17	121.6	0.362
3.2	-16	115	0.381
5.0	-15	108.7	0.4
6.8	-14	102.9	0.42
8.6	-13	97.4	0.44
10.4	-12	92.22	0.462
12.2	-11	87.35	0.484
14.0	-10	82.75	0.506
15.8	-9	78.43	0.53
17.6	-8	74.35	0.554
19.4	-7	70.5	0.579
21.2	-6	66.88	0.605
23.0	-5	63.46	0.631
24.8	-4	60.23	0.658
26.6	-3	57.18	0.686
28.4	-2	54.31	0.714
30.2	-1	51.59	0.743
32.0	0	49.02	0.773
33.8	1	46.8	0.801
35.6	2	44.31	0.835
37.4	3	42.14	0.866
39.2	4	40.09	0.899
41.0	5	38.15	0.931
42.8	6	36.32	0.965
44.6	7	34.58	0.998
46.4	8	32.94	1.033
48.2	9	31.38	1.067
50.0	10	29.9	1.102
51.8	11	28.51	1.138
53.6	12	27.18	1.174
55.4	13	25.92	1.21
57.2	14	24.73	1.246
59.0	15	23.6	1.282
60.8	16	22.53	1.319
62.6	17	21.51	1.356
64.4	18	20.54	1.393
66.2	19	19.63	1.429
68.0	20	18.75	1.467
69.8	21	17.93	1.503
71.6	22	17.14	1.54
73.4	23	16.39	1.577
75.2	24	15.68	1.613

F°	C°	Resistance (k Ω)	Voltage (V)
77.0	25	15	1.65
78.8	26	14.36	1.686
80.6	27	13.74	1.722
82.4	28	13.16	1.758
84.2	29	12.6	1.793
86.0	30	12.07	1.829
87.8	31	11.57	1.863
89.6	32	11.09	1.897
91.4	33	10.63	1.931
93.2	34	10.2	1.964
95.0	35	9.779	1.998
96.8	36	9.382	2.03
98.6	37	9.003	2.062
100.4	38	8.642	2.094
102.2	39	8.297	2.125
104.0	40	7.963	2.155
105.8	41	7.653	2.185
107.6	42	7.352	2.215
109.4	43	7.065	2.243
111.2	44	6.791	2.272
113.0	45	6.529	2.299
114.8	46	6.278	2.326
116.6	47	6.038	2.353
118.4	48	5.809	2.379
120.2	49	5.589	2.404
122.0	50	5.379	2.429
123.8	51	5.179	2.453
125.6	52	4.986	2.477
127.4	53	4.802	2.5
129.2	54	4.625	2.522
131.0	55	4.456	2.544
132.8	56	4.294	2.566
134.6	57	4.139	2.586
136.4	58	3.99	2.607
138.2	59	3.848	2.626
140.0	60	3.711	2.646
141.8	61	3.579	2.664
143.6	62	3.454	2.682
145.4	63	3.333	2.7
147.2	64	3.217	2.717
149.0	65	3.105	2.734
150.8	66	2.998	2.75
152.6	67	2.898	2.766
154.4	68	2.797	2.781
156.2	69	2.702	2.796
158.0	70	2.611	2.811

F°	C°	Resistance (kΩ)	Voltage (V)
159.8	71	2.523	2.825
161.6	72	2.439	2.838
163.4	73	2.358	2.852
165.2	74	2.28	2.865
167.0	75	2.205	2.877
168.8	76	2.133	2.889
170.6	77	2.064	2.901
172.4	78	1.997	2.912
174.2	79	1.933	2.923
176.0	80	1.871	2.934
177.8	81	1.811	2.945
179.6	82	1.754	2.955
181.4	83	1.699	2.964
183.2	84	1.645	2.974
185.0	85	1.594	2.983
186.8	86	1.544	2.992
188.6	87	1.497	3.001
190.4	88	1.451	3.009
192.2	89	1.408	3.017
194.0	90	1.363	3.025
195.8	91	1.322	3.033
197.6	92	1.282	3.04
199.4	93	1.244	3.047
201.2	94	1.207	3.054
203.0	95	1.171	3.061
204.8	96	1.136	3.068
206.6	97	1.103	3.074
208.4	98	1.071	3.08
210.2	99	1.039	3.086
212.0	100	1.009	3.092
213.8	101	0.98	3.098
215.6	102	0.952	3.103
217.4	103	0.925	3.108
219.2	104	0.898	3.114
221.0	105	0.873	3.119
222.8	106	0.848	3.123
224.6	107	0.825	3.128
226.4	108	0.802	3.133
228.2	109	0.779	3.137
230.0	110	0.758	3.141
231.8	111	0.737	3.145
233.6	112	0.717	3.15
235.4	113	0.697	3.153
237.2	114	0.678	3.157
239.0	115	0.66	3.161

F°	C°	Resistance (kΩ)	Voltage (V)
240.8	116	0.642	3.165
242.6	117	0.625	3.168
244.4	118	0.608	3.171
246.2	119	0.592	3.175
248.0	120	0.577	3.178
249.8	121	0.561	3.181
251.6	122	0.547	3.184
253.4	123	0.532	3.187
255.2	124	0.519	3.19
257.0	125	0.505	3.192
258.8	126	0.492	3.195
260.6	127	0.48	3.198
262.4	128	0.467	3.2
264.2	129	0.456	3.203
266.0	130	0.444	3.205
267.8	131	0.433	3.207
269.6	132	0.422	3.21
271.4	133	0.412	3.212
273.2	134	0.401	3.214
275.0	135	0.391	3.216
276.8	136	0.382	3.218
278.6	137	0.372	3.22
280.4	138	0.363	3.222
282.2	139	0.355	3.224
284.0	140	0.346	3.226
285.8	141	0.338	3.227
287.6	142	0.33	3.229
289.4	143	0.322	3.231
291.2	144	0.314	3.232
293.0	145	0.307	3.234
294.8	146	0.299	3.235
296.6	147	0.292	3.237
298.4	148	0.286	3.238
300.2	149	0.279	3.24
302.0	150	0.273	3.241
303.8	151	0.266	3.242
305.6	152	0.261	3.244
307.4	153	0.254	3.245
309.2	154	0.248	3.246
311.0	155	0.243	3.247
312.8	156	0.237	3.249
314.6	157	0.232	3.25
316.4	158	0.227	3.251
318.2	159	0.222	3.252
320.0	160	0.217	3.253

20 KΩ Pipeline Temperature Sensors (including temperature sensors for defroster, IDU and ODU pipes)

F°	C°	Resistance (kΩ)	Voltage (V)
-22.0	-30	361.8	0.173
-20.2	-29	339.8	0.183
-18.4	-28	319.2	0.195
-16.6	-27	300	0.206
-14.8	-26	282.2	0.218
-13.0	-25	265.5	0.231
-11.2	-24	249.9	0.245
-9.4	-23	235.3	0.259
-7.6	-22	221.6	0.273
-5.8	-21	208.9	0.288
-4.0	-20	196.9	0.304
-2.2	-19	181.4	0.328
-0.4	-18	171.4	0.345
1.4	-17	162.1	0.362
3.2	-16	153.3	0.381
5.0	-15	145	0.4
6.8	-14	137.2	0.42
8.6	-13	129.9	0.44
10.4	-12	123	0.462
12.2	-11	116.5	0.484
14.0	-10	110.3	0.507
15.8	-9	104.6	0.53
17.6	-8	99.13	0.554
19.4	-7	94	0.579
21.2	-6	89.17	0.605
23.0	-5	84.61	0.631
24.8	-4	80.31	0.658
26.6	-3	76.24	0.686
28.4	-2	72.41	0.714
30.2	-1	68.79	0.743
32.0	0	65.37	0.773
33.8	1	62.13	0.804
35.6	2	59.08	0.835
37.4	3	56.19	0.866
39.2	4	53.46	0.898
41.0	5	50.87	0.931
42.8	6	48.42	0.965
44.6	7	46.11	0.998
46.4	8	43.92	1.033
48.2	9	41.84	1.067
50.0	10	39.87	1.102
51.8	11	38.01	1.138
53.6	12	36.24	1.174
55.4	13	34.57	1.209
57.2	14	32.98	1.246
59.0	15	31.47	1.282
60.8	16	30.04	1.319
62.6	17	28.68	1.356

F°	C°	Resistance (kΩ)	Voltage (V)
64.4	18	27.39	1.393
66.2	19	26.17	1.429
68.0	20	25.01	1.466
69.8	21	23.9	1.503
71.6	22	22.85	1.54
73.4	23	21.85	1.577
75.2	24	20.9	1.614
77.0	25	20	1.65
78.8	26	19.14	1.686
80.6	27	18.32	1.722
82.4	28	17.55	1.758
84.2	29	16.8	1.793
86.0	30	16.1	1.828
87.8	31	15.43	1.863
89.6	32	14.79	1.897
91.4	33	14.18	1.931
93.2	34	13.59	1.965
95.0	35	13.04	1.998
96.8	36	12.51	2.03
98.6	37	12	2.063
100.4	38	11.52	2.094
102.2	39	11.06	2.125
104.0	40	10.62	2.155
105.8	41	10.2	2.185
107.6	42	9.803	2.215
109.4	43	9.42	2.243
111.2	44	9.054	2.272
113.0	45	8.705	2.299
114.8	46	8.37	2.326
116.6	47	8.051	2.353
118.4	48	7.745	2.379
120.2	49	7.453	2.404
122.0	50	7.173	2.429
123.8	51	6.905	2.453
125.6	52	6.648	2.477
127.4	53	6.403	2.5
129.2	54	6.167	2.522
131.0	55	5.942	2.544
132.8	56	5.726	2.565
134.6	57	5.519	2.586
136.4	58	5.32	2.607
138.2	59	5.13	2.626
140.0	60	4.948	2.646
141.8	61	4.773	2.664
143.6	62	4.605	2.682
145.4	63	4.443	2.7
147.2	64	4.289	2.717
149.0	65	4.14	2.734

Appendices

F°	C°	Resistance (kΩ)	Voltage (V)
150.8	66	3.998	2.75
152.6	67	3.861	2.766
154.4	68	3.729	2.781
156.2	69	3.603	2.796
158.0	70	3.481	2.811
159.8	71	3.364	2.825
161.6	72	3.252	2.838
163.4	73	3.144	2.852
165.2	74	3.04	2.865
167.0	75	2.94	2.877
168.8	76	2.844	2.889
170.6	77	2.752	2.901
172.4	78	2.663	2.912
174.2	79	2.577	2.923
176.0	80	2.495	2.934
177.8	81	2.415	2.944
179.6	82	2.339	2.954
181.4	83	2.265	2.964
183.2	84	2.194	2.974
185.0	85	2.125	2.983
186.8	86	2.059	2.992
188.6	87	1.996	3.001
190.4	88	1.934	3.009
192.2	89	1.875	3.017
194.0	90	1.818	3.025
195.8	91	1.763	3.033
197.6	92	1.71	3.04
199.4	93	1.658	3.047
201.2	94	1.609	3.054
203.0	95	1.561	3.061
204.8	96	1.515	3.068
206.6	97	1.47	3.074
208.4	98	1.427	3.08
210.2	99	1.386	3.086
212.0	100	1.346	3.092
213.8	101	1.307	3.098
215.6	102	1.269	3.103
217.4	103	1.233	3.108
219.2	104	1.198	3.114
221.0	105	1.164	3.119
222.8	106	1.131	3.123
224.6	107	1.099	3.128
226.4	108	1.069	3.133
228.2	109	1.039	3.137
230.0	110	1.01	3.141
231.8	111	0.9825	3.145
233.6	112	0.9556	3.15
235.4	113	0.9295	3.153

F°	C°	Resistance (kΩ)	Voltage (V)
237.2	114	0.9043	3.157
239.0	115	0.8799	3.161
240.8	116	0.8562	3.165
242.6	117	0.8333	3.168
244.4	118	0.8111	3.171
246.2	119	0.7895	3.175
248.0	120	0.7687	3.178
249.8	121	0.7485	3.181
251.6	122	0.7289	3.184
253.4	123	0.7099	3.187
255.2	124	0.6915	3.19
257.0	125	0.6736	3.192
258.8	126	0.6563	3.195
260.6	127	0.6395	3.198
262.4	128	0.6232	3.2
264.2	129	0.6074	3.203
266.0	130	0.5921	3.205
267.8	131	0.5772	3.207
269.6	132	0.5627	3.21
271.4	133	0.5487	3.212
273.2	134	0.5351	3.214
275.0	135	0.5219	3.216
276.8	136	0.509	3.218
278.6	137	0.4966	3.22
280.4	138	0.4845	3.222
282.2	139	0.4727	3.224
284.0	140	0.4613	3.226
285.8	141	0.4502	3.227
287.6	142	0.4394	3.229
289.4	143	0.4289	3.231
291.2	144	0.4187	3.232
293.0	145	0.4088	3.234
294.8	146	0.3992	3.235
296.6	147	0.3899	3.237
298.4	148	0.3808	3.238
300.2	149	0.3719	3.24
302.0	150	0.3633	3.241
303.8	151	0.3549	3.242
305.6	152	0.3468	3.244
307.4	153	0.3389	3.245
309.2	154	0.3312	3.246
311.0	155	0.3237	3.247
312.8	156	0.3164	3.249
314.6	157	0.3093	3.25
316.4	158	0.3024	3.251
318.2	159	0.2956	3.252
320.0	160	0.2891	3.253

50 K Ω Discharge Temperature Sensors (including discharge air temperature sensor)

F°	C°	Resistance (k Ω)	Voltage (V)
-22.0	-30	911.56	0.036
-20.2	-29	853.66	0.038
-18.4	-28	799.98	0.041
-16.6	-27	750.18	0.043
-14.8	-26	703.92	0.046
-13.0	-25	660.93	0.049
-11.2	-24	620.94	0.052
-9.4	-23	583.72	0.056
-7.6	-22	549.04	0.059
-5.8	-21	516.71	0.063
-4.0	-20	486.55	0.066
-2.2	-19	458.4	0.07
-0.4	-18	432.1	0.075
1.4	-17	407.51	0.079
3.2	-16	384.51	0.084
5.0	-15	362.99	0.088
6.8	-14	342.83	0.094
8.6	-13	323.94	0.099
10.4	-12	306.23	0.104
12.2	-11	289.61	0.11
14.0	-10	274.02	0.116
15.8	-9	259.37	0.123
17.6	-8	245.61	0.129
19.4	-7	232.67	0.136
21.2	-6	220.5	0.143
23.0	-5	209.05	0.151
24.8	-4	195.97	0.158
26.6	-3	188.12	0.167
28.4	-2	178.65	0.175
30.2	-1	169.68	0.184
32.0	0	161.02	0.193
33.8	1	153	0.202
35.6	2	145.42	0.212
37.4	3	135.96	0.223
39.2	4	131.5	0.233
41.0	5	126.17	0.242
42.8	6	119.08	0.256
44.6	7	113.37	0.267
46.4	8	107.96	0.28
48.2	9	102.85	0.292
50.0	10	98.006	0.306
51.8	11	93.42	0.319
53.6	12	89.075	0.333
55.4	13	84.956	0.348
57.2	14	81.052	0.362
59.0	15	77.349	0.378

F°	C°	Resistance (k Ω)	Voltage (V)
60.8	16	73.896	0.393
62.6	17	70.503	0.41
64.4	18	67.338	0.427
66.2	19	64.333	0.444
68.0	20	61.478	0.462
69.8	21	58.766	0.48
71.6	22	56.189	0.499
73.4	23	53.738	0.518
75.2	24	51.408	0.537
77.0	25	49.191	0.558
78.8	26	47.082	0.578
80.6	27	45.074	0.599
82.4	28	43.163	0.621
84.2	29	41.313	0.643
86.0	30	39.61	0.665
87.8	31	37.958	0.688
89.6	32	36.384	0.711
91.4	33	34.883	0.735
93.2	34	33.453	0.759
95.0	35	32.088	0.784
96.8	36	30.787	0.809
98.6	37	29.544	0.835
100.4	38	28.359	0.86
102.2	39	27.227	0.886
104.0	40	26.147	0.913
105.8	41	25.114	0.94
107.6	42	24.128	0.967
109.4	43	23.186	0.994
111.2	44	22.286	1.022
113.0	45	21.425	1.05
114.8	46	20.601	1.078
116.6	47	19.814	1.107
118.4	48	19.061	1.136
120.2	49	18.34	1.164
122.0	50	17.651	1.193
123.8	51	16.99	1.223
125.6	52	16.358	1.252
127.4	53	15.753	1.281
129.2	54	15.173	1.311
131.0	55	14.618	1.34
132.8	56	14.085	1.37
134.6	57	13.575	1.4
136.4	58	13.086	1.429
138.2	59	12.617	1.459
140.0	60	12.368	1.475
141.8	61	11.736	1.518

F°	C°	Resistance (kΩ)	Voltage (V)
143.6	62	11.322	1.548
145.4	63	10.925	1.577
147.2	64	10.544	1.606
149.0	65	10.178	1.635
150.8	66	9.8269	1.664
152.6	67	9.4896	1.693
154.4	68	9.1655	1.722
156.2	69	8.9542	1.741
158.0	70	8.5551	1.778
159.8	71	5.9676	1.806
161.6	72	7.9913	1.834
163.4	73	7.7257	1.862
165.2	74	7.4702	1.889
167.0	75	7.2245	1.916
168.8	76	6.9882	1.943
170.6	77	6.7608	1.969
172.4	78	6.542	1.995
174.2	79	6.3315	2.021
176.0	80	6.1288	2.046
177.8	81	5.9336	2.071
179.6	82	5.7457	2.096
181.4	83	5.5647	2.12
183.2	84	5.3903	2.144
185.0	85	5.2223	2.168
186.8	86	5.0605	2.191
188.6	87	4.9044	2.214
190.4	88	4.7541	2.237
192.2	89	4.6091	2.259
194.0	90	4.4693	2.281
195.8	91	4.3345	2.302
197.6	92	4.2044	2.323
199.4	93	4.0789	2.344
201.2	94	3.9579	2.364
203.0	95	3.841	2.384
204.8	96	3.7283	2.404
206.6	97	3.6194	2.423
208.4	98	3.5143	2.442
210.2	99	3.4128	2.46
212.0	100	3.3147	2.478
213.8	101	3.22	2.496
215.6	102	3.1285	2.514
217.4	103	3.0401	2.531
219.2	104	2.9547	2.547
221.0	105	2.8721	2.564
222.8	106	2.7922	2.58
224.6	107	2.715	2.595

F°	C°	Resistance (kΩ)	Voltage (V)
226.4	108	2.6404	2.611
228.2	109	2.5682	2.626
230.0	110	2.4983	2.64
231.8	111	2.4308	2.655
233.6	112	2.3654	2.669
235.4	113	2.3021	2.682
237.2	114	2.2409	2.696
239.0	115	2.1816	2.709
240.8	116	2.1242	2.722
242.6	117	2.0686	2.734
244.4	118	2.0148	2.747
246.2	119	1.9626	2.759
248.0	120	1.9123	2.77
249.8	121	1.8652	2.781
251.6	122	1.8158	2.793
253.4	123	1.7698	2.804
255.2	124	1.7253	2.814
257.0	125	1.6821	2.825
258.8	126	1.6402	2.835
260.6	127	1.5996	2.845
262.4	128	1.5602	2.855
264.2	129	1.522	2.864
266.0	130	1.485	2.873
267.8	131	1.449	2.882
269.6	132	1.4141	2.891
271.4	133	1.3803	2.9
273.2	134	1.3474	2.908
275.0	135	1.3155	2.916
276.8	136	1.2846	2.924
278.6	137	1.2545	2.932
280.4	138	1.2233	2.94
282.2	139	1.1969	2.947
284.0	140	1.1694	2.955
285.8	141	1.1476	2.96
287.6	142	1.1166	2.969
289.4	143	1.0913	2.975
291.2	144	1.0667	2.982
293.0	145	1.0429	2.988
294.8	146	1.0197	2.995
296.6	147	0.9971	3.001
298.4	148	0.9752	3.007
300.2	149	0.9538	3.013
302.0	150	0.9331	3.018

Appendices

Refrigerant R-410A Temperature/Pressure List

PSIG	°F
12	-37.7
14	-34.7
16	-32.0
18	-29.4
20	-36.9
22	-24.5
24	-22.2
26	-20.0
28	-17.9
30	-15.8
32	-13.8
34	-11.9
36	-10.1
38	-8.3
40	-6.5
42	-4.5
44	-3.2
46	-1.6
48	0
50	1.5
52	3
54	4.5
56	5.9
58	7.3
60	8.6
62	10
64	11.3
66	12.6
68	13.8
70	15.1
72	16.3
74	17.5
76	18.7
78	19.8
80	21
82	22.1
84	23.2
86	24.3
88	25.4
90	26.4
92	27.4
94	28.5
96	29.5
98	30.5

PSIG	°F
100	31.2
102	32.2
104	33.2
106	34.1
108	35.1
110	35.5
112	36.9
114	37.8
116	38.7
118	39.5
120	40.5
122	41.3
124	42.2
126	43
128	43.8
130	44.7
132	45.5
134	46.3
136	47.1
138	47.9
140	48.7
142	49.5
144	50.3
146	51.1
148	51.8
150	52.5
152	53.3
154	54
156	54.8
158	55.5
160	56.2
162	57
164	57.7
166	58.4
168	59
170	59.8
172	60.5
174	61.1
176	61.8
178	62.5
180	63.1
182	63.8
184	64.5
186	65.1

PSIG	°F
188	65.8
190	66.4
192	67
194	67.7
196	68.3
198	68.9
200	69.5
202	70.1
204	70.7
206	71.4
208	72
210	72.6
212	73.2
214	73.8
216	74.3
218	74.9
220	75.5
222	76.1
224	76.7
226	77.2
228	77.8
230	78.4
232	78.9
234	79.5
236	80
238	80.6
240	81.1
242	81.6
244	82.2
246	82.7
248	83.3
250	83.8
252	84.3
254	84.8
256	85.4
258	85.9
260	86.4
262	86.9
264	87.4
266	87.9
268	88.4
270	88.9
272	89.4
274	89.9

PSIG	°F
276	90.4
278	90.9
280	91.4
282	91.9
284	92.4
286	92.8
288	93.3
290	93.8
292	94.3
294	94.8
296	95.2
298	95.7
300	96.2
302	96.6
304	97.1
306	97.5
308	98
310	98.4
312	98.9
314	99.3
316	99.7
318	100.2
320	100.7
322	101.1
324	101.6
326	102
328	102.4
330	102.9
332	103.3
334	103.7
336	104.2
338	104.6
340	105.1
342	105.4
344	105.8
346	106.3
348	106.6
350	107.1
352	107.5
354	107.9
356	108.3
358	108.8
360	109.2
362	109.6

Appendices

PSIG	°F
364	110
366	110.4
368	110.8
370	111.2
372	111.6
374	112
376	112.4
378	112.6
380	113.1
382	113.5
384	113.9
386	114.3
388	114.7
390	115
392	115.5
394	115.8
396	116.2
398	116.6
400	117
402	117.3
404	117.7
406	118.1
408	118.5
410	118.8
412	119.2
414	119.6
416	119.9
418	120.3
420	120.7
422	121
424	121.4
426	121.7
428	122.1
430	122.5
432	122.8
434	123.2
436	123.5
438	123.9
440	124.2
442	124.6
444	124.9
446	125.3
448	125.6
450	126

PSIG	°F
452	126.3
454	126.6
456	127
458	127.3
460	127.7
462	128
464	128.3
466	128.7
468	129
470	129.3
472	129.7
474	130
476	130.3
478	130.7
480	131
482	131.3
484	131.6
486	132
488	132.3
490	132.6
492	132.9
494	133.3
496	133.6
498	133.9
500	134
502	134.5
504	134.8
506	135.2
508	135.5
510	135.8
512	136.1
514	136.4
516	136.7
518	137
520	137.3
522	137.6
524	137.9
526	138.3
528	138.6
530	138.9
532	139.2
534	139.5
536	139.8
538	140.1

PSIG	°F
540	140.4
544	141
548	141.6
552	142.1
556	142.7
560	143.3
564	143.9
568	144.5
572	145
576	145.6
580	146.2
584	146.7
588	147.3
592	147.9
596	148.4
600	149
604	149.5
608	150.1
612	150.6
616	151.2
620	151.7
624	152.3
628	152.8
632	153.4
636	153.9
640	154.5
644	155
648	155.5
652	156.1
656	156.6
660	157.1
664	157.7
668	158.2
672	158.7
676	159.2
680	159.8
684	160.3
688	160.8
692	161.3
696	161.8

Appendices

Refrigerant R-410A Temperature/Pressure List (kPa/°C)

kPa	°C
275	-30
286	-29
298	-28
311	-27
324	-26
334	-25
348	-24
363	-23
375	-22
391	-21
404	-20
424	-19
435	-18
453	-17
468	-16
483	-15
504	-14
520	-13
538	-12
556	-11
579	-10
598	-9
618	-8
639	-7
660	-6
682	-5
705	-4
728	-3
752	-2
777	-1

kPa	°C
803	0
823	1
851	2
879	3
903	4
937	5
962	6
994	7
1020	8
1050	9
1090	10
1110	11
1150	12
1180	13
1220	14
1250	15
1280	16
1320	17
1350	18
1400	19
1440	20
1470	21
1520	22
1560	23
1600	24
1640	25
1680	26
1730	27
1780	28
1820	29

kPa	°C
1880	30
1910	31
1960	32
2030	33
2080	34
2130	35
2180	36
2240	37
2290	38
2350	39
2410	40
2460	41
2510	42
2580	43
2650	44
2710	45
2770	46
2840	47
2910	48
2980	49
3050	50
3100	51
3180	52
3250	53
3320	54
3400	55
3480	56
3540	57
3630	58
3720	59

Operation Tools

The following tools will be used: 1) Liquid-level gauge; 2) Screwdriver; 3) Electric driven rotary hammer; 4) Drill; 5) Flare Tool; 6) Torque wrench; 7) Open-end wrench; 8) Pipe cutter; 9) Leak detector; 10) Vacuum pump; 11) Pressure gauge; 12) Multi-meter; 13) Hexagon wrench; 14) Measuring tape.

www.geappliances.com